

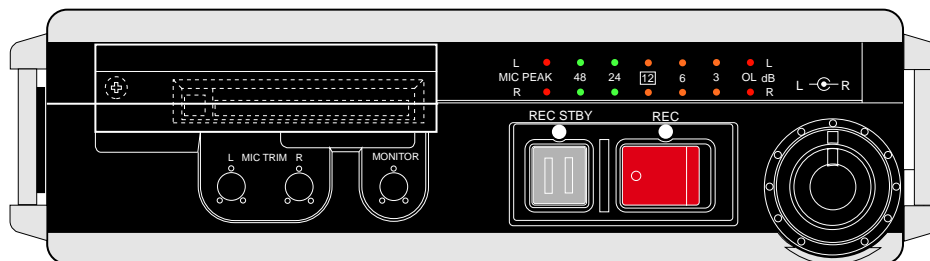

FIELD MEMORY RECORDER  
Model **FR-2LE**



**Owner's Manual**

 <div style="display: inline-block; background-color: black; color: white; padding: 5px; text-align: center; font-weight: bold; margin: 0 10px;"> <b>CAUTION</b>                  RISK OF ELECTRIC SHOCK                  DO NOT OPEN             </div> 
<p>CAUTION: TO REDUCE THE RISK OF ELECTRIC SHOCK, DO NOT REMOVE COVER (OR BACK). NO USER - SERVICEABLE PARTS INSIDE. REFER SERVICING TO QUALIFIED SERVICE PERSONNEL.</p>

**CAUTION:**  
TO PREVENT ELECTRIC SHOCK, MATCH WIDE BLADE OF PLUG TO WIDE SLOT, FULLY INSERT.

**ATTENTION:**  
POUR ÉVITER LES CHOCS ÉLECTRIQUES, INTRODUIRE LA LAME LA PLUS LARGE DE LA FICHE DANS LA BORNE CORRESPONDANTE DE LA PRISE ET POUSSER JUSQU' AU FOND.



The lightning flash with arrowhead symbol, within an equilateral triangle, is intended to alert the user to the presence of uninsulated "dangerous voltage" within the product's enclosure that may be of sufficient magnitude to constitute a risk of electric shock to persons.



The exclamation point within an equilateral triangle is intended to alert the user to the presence of important operating and maintenance (servicing) instructions in the literature accompanying the appliance.

## "WARNING"

"TO REDUCE THE RISK OF FIRE OR ELECTRIC SHOCK, DO NOT EXPOSE THIS APPLIANCE TO RAIN OR MOISTURE."

## SAFETY INSTRUCTIONS

1. Read Instructions - All the safety and operating instructions should be read before the appliance is operated.
2. Retain Instructions - The safety and operating instructions should be retained for future reference.
3. Heed Warnings - All warnings on the appliance and in the operating instructions should be adhered to.
4. Follow Instructions - All operating and use instructions should be followed.
5. Water and Moisture - The appliance should not be used near water - for example, near a bathtub, washbowl, kitchen sink, laundry tub, in a wet basement, or near a swimming pool, and the like.
6. Carts and Stands - The appliance should be used only with a cart or stand that is recommended by the manufacturer.



An appliance and cart combination should be moved with care. Quick stops, excessive force, and uneven surfaces may cause the appliance and cart combination to overturn.

7. Wall or Ceiling Mounting - The appliance should be mounted to a wall or ceiling only as recommended by the manufacturer.
8. Ventilation - The appliance should be situated so that its location or position does not interfere with its proper ventilation. For example, the appliance should not be situated on a bed, sofa, rug, or similar surface that may block the ventilation openings; or, placed in a built-in installation, such as a bookcase or cabinet that may impede the flow of air through the ventilation openings.
9. Heat - The appliance should be situated away from heat sources such as radiators, heat registers, stoves, or other appliances (including amplifiers) that produce heat.
10. Power Sources - The appliance should be connected to a power supply only of the type described in the operating instructions or as marked on the appliance.
11. Grounding or Polarization - The precautions that should be taken so that the grounding or polarization means of an appliance is not defeated.

12. Power Cord Protection - Power supply cords should be routed so that they are not likely to be walked on or pinched by items placed upon or against them, paying particular attention to cords at plugs, convenience receptacles, and the point where they exit from the appliance.
13. Cleaning - The appliance should be cleaned only as recommended by the manufacturer.
14. Nonuse Periods - The power cord of the appliance should be unplugged from the outlet when left unused for a long period of time.
15. Object and Liquid Entry - Care should be taken so that objects do not fall and liquids are not spilled into the enclosure through openings.
16. Damage Requiring Service - The appliance should be serviced by qualified service personnel when:
  - A. The power supply cord or the plug has been damaged; or
  - B. Objects have fallen, or liquid has been spilled into the appliance; or
  - C. The appliance has been exposed to rain; or
  - D. The appliance does not appear to operate normally or exhibits a marked change in performance; or
  - E. The appliance has been dropped, or the enclosure damaged.
17. Servicing - The user should not attempt to service the appliance beyond that described in the operating instructions. All other servicing should be referred to qualified service personnel.
18. The appliance should be situated away from drops of water or spray of water.
19. Objects containing liquid such as vase must not be put on the appliance.
20. The appliance is not completely isolated from the power supply even if the power switch is at off position.
21. Apparatus shall not be exposed to dripping or splashing and no objects filled with liquids, such as vases, shall be placed on the apparatus.
22. Only use attachments/accessories specified by the manufacturer.
23. An appliance with a protective earth terminal should be connected to a mains outlet with a protective earth connection.
24. An appliance should be placed in a position where an AC plug / inlet can be easily pulled out by hand.
25. Main plug is used as the disconnection device. It shall remain readily operable and should not be obstructed during intended use. To be completely disconnected the apparatus from supply mains, the mains plug of the apparatus shall be disconnected from the mains socket outlet completely.

## Important Safety Instructions

- 1) Read these instructions.
- 2) Keep these instructions.
- 3) Heed all warnings.
- 4) Follow all instructions.
- 5) Do not use this apparatus near water.
- 6) Clean only with dry cloth.
- 7) Do not block any ventilation openings. Install in accordance with the manufacturer's instructions.
- 8) Do not install near any heat sources such as radiators, heat registers, stoves, or other apparatus (including amplifiers) that produce heat.
- 9) Do not defeat the safety purpose of the polarized or grounding-type plug. A polarized plug has two blades with one wider than the other. A grounding type plug has two blades and a third grounding prong. The wide blade or the third prong are provided for your safety. If the provided plug does not fit into your outlet, consult an electrician for replacement of the obsolete outlet.
- 10) Protect the power cord from being walked on or pinched particularly at plugs, convenience receptacles, and the point where they exit from the apparatus.
- 11) Only use attachments/accessories specified by the manufacturer.
- 12) Use only with the cart, stand, tripod, bracket, or table specified by the manufacturer, or sold with the apparatus. When a cart is used, use caution when moving the cart/apparatus combination to avoid injury from tip-over.
- 13) Unplug this apparatus during lightning storms or when unused for long periods of time.
- 14) Refer all servicing to qualified service personnel. Servicing is required when the apparatus has been damaged in any way, such as power-supply cord or plug is damaged, liquid has been spilled or objects have fallen into the apparatus, the apparatus has been exposed to rain or moisture, does not operate normally, or has been dropped.



## Table of contents

<b>About this manual</b> .....	<b>9</b>
<b>Precautions</b> .....	<b>9</b>
<b>MP3 (MPEG Layer-3)</b> .....	<b>10</b>
<b>Precautions on installation</b> .....	<b>11</b>
<b>Brief guide to this manual</b> .....	<b>11</b>
Manual organization .....	11
Manual conventions .....	14

## **Chapter 1: Product overview** ..... **15**

<b>Overview</b> .....	<b>16</b>
<b>Main features</b> .....	<b>16</b>
<b>Supplied accessories</b> .....	<b>17</b>
<b>About software update</b> .....	<b>18</b>

## **Chapter 2: Before using the FR-2LE** ..... **19**

<b>About power supply</b> .....	<b>20</b>
Operating the FR-2LE on the AC adaptor .....	20
Connecting the AC adaptor .....	20
Operating with batteries .....	21
Inserting four size AA batteries to the battery case .....	21
Setting the battery case (or a Tamiya battery) to the unit .....	22
Reducing the battery power consumption .....	24
Turning on the power .....	25
Battery remaining indication .....	26
<b>Formatting a memory card</b> .....	<b>27</b>
<b>Setting the display backlight/contrast</b> .....	<b>29</b>
Turning the backlight on or off .....	29
Adjusting the display contrast .....	30
<b>About the internal realtime clock</b> .....	<b>31</b>

<b>About memory card .....</b>	<b>32</b>
Inserting/removing a memory card .....	32
Removing a card .....	33
Inserting a card .....	34
<b>How to attach the shoulder belt to the unit .....</b>	<b>36</b>

## **Chapter 3: Names and functions .....37**

<b>Front panel .....</b>	<b>38</b>
<b>Top panel .....</b>	<b>39</b>
<b>Left side panel .....</b>	<b>41</b>
<b>Right side panel .....</b>	<b>42</b>
<b>Back panel .....</b>	<b>42</b>
<b>Bottom panel .....</b>	<b>43</b>
<b>Details about screens .....</b>	<b>44</b>
Home screen .....	44
When no memory card is set .....	44
When a formatted blank memory card is set .....	44
When a recorded memory card is set .....	44
MENU mode screens .....	46
Warning message screen .....	46

## **Chapter 4: Basic connections .....49**

<b>Audio connections .....</b>	<b>50</b>
Connecting to an external microphone .....	50
Connecting to the line outputs of an external audio device .....	50
Connecting to a monitor system .....	51
Connecting to headphones .....	51
<b>Other connections .....</b>	<b>52</b>
Connecting to a PC .....	52
Connecting to the remote controller .....	52

**Chapter 5: Recording / playback .....53**

**About recording system .....54**

**Setup before you start recording .....55**

- Setup in quick setup mode .....55
  - How to make setting in the quick setup mode .....56
  - ALC (Auto Level Control) setting (if needed) .....57
  - HPF (High Pass Filter ) on/off setting (if needed) .....57
  - Phantom power on/off setting (if needed) .....57
  - Recording source selection (must setting) .....57
- Using the MENU mode .....58
  - Default file name setting (if needed) .....58
  - Pre record function on/off setting (if needed) .....58
  - Maximum file size setting (if needed) .....59
  - Monitor output mode setting (if needed) .....59
  - Error tone output setting (if needed) .....59
  - Internal speaker output mode setting (if needed) .....59
  - Time display mode setting (if needed) .....59

**Recording audio .....60**

- Adjusting the input gain .....60
- Adjusting the recording level .....60
  - Adjusting the external source (microphone or line input) level .....60
  - Adjusting the internal microphone level .....61
- Starting recording .....62

**Setting cue points .....63**

- Setting a cue point on-the-fly .....63
- Viewing cue point information .....63
- Deleting a cue point in realtime .....64

**Playback .....65**

- Normal audio playback .....65
- Cueing playback .....66

**Skip/locate functions .....66**

- Skipping by file .....66
- Skipping by cue point .....66

Locating to the beginning (ABS 0) of a file .....	67
Locating to the end (REC END) of a file .....	67

## **Chapter 6: Exporting audio files to a PC .....69**

<b>Connecting the FR-2LE to a PC .....</b>	<b>70</b>
USB connection between the FR-2LE to a PC .....	71
Copying an audio file to a PC hard disk .....	72
Copying a file from a PC to a memory card .....	72
Example of exporting audio data to a PC software application .....	73
<b>Protecting a memory card .....</b>	<b>76</b>

## **Chapter 7: MENU mode .....77**

<b>How to operate in the MENU mode .....</b>	<b>78</b>
Menu items .....	79
<b>File menu .....</b>	<b>80</b>
Locating the beginning of the selected file (Locate) .....	80
Renaming the file name of the selected file (Rename) .....	81
Removing a file from the ADL (Remove) .....	83
Restoring a removed file to the ADL (Prev. Insert / Next Insert) .....	84
<b>Disk menu .....</b>	<b>86</b>
Formatting a memory card (Format) .....	86
Editing a reel number of a memory card (Reel No) .....	89
Enabling or disabling resume function (Resume) .....	90
<b>Setup menu .....</b>	<b>91</b>
Enabling or disabling the auto level control and limiter functions (ALC) .....	91
Enabling or disabling the high pass filter (HPF) .....	92
Selecting the default recording format (Def. FS/BIT) .....	93
Selecting the recording source (Source Sel) .....	94
Turning the phantom power on or off (Phantom) .....	95
Selecting the monitor mode (Monitor Mode) .....	96
Enabling or disabling the internal speaker (Speaker Out) .....	97
Selecting the default file name type (File Name Mode) .....	98
Setting the default file name (Default File Name) .....	99

Selecting the take number .....100

Renaming the scene name .....100

Making the edited file name (scene name + take number) effective .....101

Resetting a default file name .....101

Enabling or disabling the pre record function (Pre Rec) .....102

Selecting the time display mode (Time Disp) .....103

Selecting the remaining display mode (Remain Display) .....104

Setting the maximum file size (Max File Size) .....105

Selecting the internal battery type (Battery Type) .....106

Enabling or disabling the error tone function (Error Tone) .....107

Adjusting the real time clock (Adjust Real Time Clock) .....108

Showing the ROM version (Version) .....109

Initializing the Setup menu settings (Initial Setup) .....110

Update the software (Version Up) .....111

**Chapter 8: Main specifications .....113**

**Inputs / Outputs .....113**

**Recording / Playback .....113**

**General .....114**

**Physical dimensions .....115**

**Declaration of EC Directive .....116**



## About this manual

This manual covers all about how to use the Fostex FR-2LE Field Memory Recorder.

Its explanations assume that you have basic knowledge and experience of professional digital recording.

To understand the FR-2LE features and learn how to use the FR-2LE quickly and roughly, we recommend reading "Chapter 1: Introduction" and "Chapter 3: Names and Functions".

Chapter 2 ("Before using the FR-2LE") describes important basics about power supply and memory cards. We recommend to read this chapter before using the FR-2LE first time.

## Precautions

- When supplying the power to the unit from the AC power outlet, only use the supplied AC adaptor.  
If you use any other AC adaptor, the unit may not work correctly and there is a serious risk of damage to the unit.
- Make sure that the voltage of your AC power outlet matches the voltage requirements printed on the AC adaptor.  
If you wish to use the unit in a country where the voltage of the AC power outlet does not match your AC adaptor, ask your local Fostex dealer or service station for purchasing an appropriate AC adaptor.  
Note that the AC adaptor can be used both in 50 Hz and 60 Hz areas.
- When operating the unit with batteries, use alkaline, Ni-Cd, Ni-MH batteries, or the Tamiya (7.2V) battery.  
Rechargeable batteries should be fully charged.
- When removing batteries or disconnecting the AC adaptor, make sure that the unit [POWER] switch is set to "OFF".  
Removing batteries or disconnecting the AC adaptor while the power is "ON" may damage data because the unit always transfers data between the current card and memory.
- While the unit is accessing a memory card (for example, during recording), never turn off the power. Make sure that the unit completely stops accessing the card before you turn off the power.  
Otherwise, recorded data may be lost, as well as the memory card maybe damaged.

Note that Fostex assumes no responsibility on data loss or whatsoever due to use of the unit.

- Fostex is not responsible for any "direct damage" or "indirect damage" caused by using the unit.

- Do not let water or other liquid, or metal objects such as pins, accidentally enter the inside of the unit (especially inside of the card slots) because this may lead to electric shock or damage. Should water enter the inside of the unit, turn off the power, unplug the AC adaptor and remove batteries, and consult your dealer or the nearest FOSTEX service station.
- Do not drop the unit or give it a strong shock. The internal circuits, display, panels may be damaged. Although the unit is designed to operate outside, handle the unit with great care because it is a precision machine.
- To prevent possible electric shock and damage to the unit, do not remove the cover or reach the inside of the unit.
- When using the supplied carrying belt, to prevent the unit from dropping accidentally, make sure that it is attached to the unit correctly.
- Do not give a strong shock to the LCD display. The liquid used inside the LCD display is toxic. If the liquid is spilled, do not suck it in. If it is stained to your hand or skin, wash immediately with plenty of water.

<p><b>&lt;Important&gt;</b> <i>The model name, power requirement and serial number of the unit are labeled on the bottom panel.</i></p>	<table border="1"><tr><td><b>FOSTEX</b> MODEL FR-2LE FIELD MEMORY RECORDER</td></tr><tr><td>FOSTEX CO. INPUT: 12VDC ---</td></tr><tr><td>SERIAL NO. フォステクスカンパニー</td></tr><tr><td>MADE IN CHINA</td></tr></table>	<b>FOSTEX</b> MODEL FR-2LE FIELD MEMORY RECORDER	FOSTEX CO. INPUT: 12VDC ---	SERIAL NO. フォステクスカンパニー	MADE IN CHINA
<b>FOSTEX</b> MODEL FR-2LE FIELD MEMORY RECORDER					
FOSTEX CO. INPUT: 12VDC ---					
SERIAL NO. フォステクスカンパニー					
MADE IN CHINA					

## MP3 (MPEG Layer-3)

Supply of this product does not convey a license nor imply any right to distribute content with this product in revenue-generating broadcast systems (terrestrial, satellite, cable and/or other distribution channels), streaming applications (via Internet, internets and/or other networks), other content distribution systems (pay-audio or audio-on-demand applications and the like) or on physical media (compact discs, digital versatile discs, semiconductor chips, hard drives, memory cards and the like).

An independent license for such use is required. For details, please visit “<http://mp3licensing.com>.”

## ***Precautions on installation***

- **Do not install the unit in the following conditions.**
  - in a extremely hot or cold place
  - in a moist place
  - in a shaky or unstable place
  - in a dusty place
  - in a strong magnetic field or near a device which generates a magnetic field
  - in the direct sunshine
  - in the direct rain or water
  
- **Notes on moisture condensation**

When you bring the unit from a cold place to a warm place, moisture may condense on the drive, display, panels, etc.  
In such a case, leave the unit for a while until it warms up and evaporates any moisture.

## ***Brief guide to this manual***

This manual is intended to be used as a guidebook for using the Fostex FR-2LE Field Memory Recorder.

The manual is divided into Chapters. Each Chapter covers instructions for a specific subject or feature of the FR-2LE which you should know for using the unit, as well as safety instructions, precautions, etc. Please retain this manual at hand so that you can read it whenever necessary.

### **<Manual organization>**

The following shows a brief introduction of each chapter, though you may know the contents of each chapter from the "Table of Contents".

#### **Chapter 1: Product overview**

This chapter describes the brief introduction of the FR-2LE, as well as main features.

#### **Chapter 2: Before using the FR-2LE**

This chapter describes some notes on the power supply, as well as memory cards including the initial format.

Read this chapter before using the FR-2LE for the first time.

### Chapter 3: Names of Functions

This chapter describes names and functions of keys and controls on the front and top panels, as well as those of connectors on the left and right side panels. If you are familiar with digital equipment, you may roughly understand the FR-2LE functions by looking through this chapter.

### Chapter 4: Basic connection

This chapter describes basic connection between the FR-2LE and external devices. It includes details about how to connect analog audio signals, as well as how to connect a PC to the unit via [USB] connector.

### Chapter 5: Recording/playback

This chapter describes analog audio recording/playback using the FR-2LE. Descriptions for storing cue points, as well as the skip and locate functions, are also included.

### Chapter 6: Exporting audio files to a PC

This chapter describes how to copy recorded audio file data (WAV file/MP3 file) to a PC hard disk and how to export data to a computer application software such as the Digidesign Pro Tools.

### Chapter 7: MENU mode

This chapter describes details about each menu items in the MENU mode. Four menus are available in the MENU mode. Each menu includes various menu items as shown below. (Note that menu items may change when the FR-2LE is upgraded.)

#### 1) File menu (See page 80 for details.)

Includes five menu items regarding audio files.

<b>Locate</b>	Used to locate the beginning of the selected audio file.
<b>Rename</b>	Used to rename an audio file.
<b>Remove</b>	Used to remove an audio file from the ADL (Audio Decision List).
<b>Prev. Insert</b>	Used to restore a removed audio file to the ADL.
<b>Next Insert</b>	Used to restore a removed audio file to the ADL.

#### 2) Disk menu (See page 86 for details.)

Includes three menu items regarding memory cards.

<b>Format</b>	Used to format a memory card.
<b>Reel No.</b>	Used to edit the reel number of a memory card.
<b>Resume</b>	Used to enable or disable the resume function.

**3) Setup menu (See page 91 for details.)**

Includes 19 menu items for FR-2LE preferences, etc.

<b>ALC</b>	Used to enable or disable the auto level control or the limiter.
<b>HPF</b>	Used to enable or disable the high pass filter.
<b>Def. FS/BIT</b>	Used to set recording format (Fs/bit) of a memory card.
<b>Source Sel.</b>	Used to select the recording sources (the external sources or internal microphones).
<b>Phantom</b>	Used to enable or disable the phantom power.
<b>Monitor Mode</b>	Used to set the monitor output mode (stereo or mono).
<b>Speaker Out</b>	Used to enable or disable the internal speaker.
<b>File Name Mode</b>	Used to select the file name mode.
<b>Default File Name</b>	Used to set the default scene name and take number for a file name when the file name mode is set to "Take".
<b>Pre Rec</b>	Used to enable or disable the pre record function.
<b>Time Display</b>	Used to select the time display mode on the Home screen.
<b>Remain Display</b>	Used to select the remaining display mode on the Home screen.
<b>Max. File Size</b>	Used to set the maximum audio file size.
<b>Battery Type</b>	Used to select the battery type for operating the unit.
<b>Error Tone</b>	Used to enable or disable the error tone function.
<b>Adjust Real Time Clock</b>	Used to adjust the real time clock.
<b>Version</b>	Shows the current ROM version.
<b>Init Setup</b>	Used to initialize all Setup menu item settings.
<b>Version Up</b>	Used to upgrade the software.

**5) USB mode menu (See page 69 for details.)**

Includes 2 menu items for USB mode which enables PC connection for file transfer.

<b>Card Protect</b>	Used to enable or disable memory card protection.
<b>USB Device Mode</b>	Used to enable or disable USB connection to a PC.

**Chapter 8: Specifications**

This chapter describes mechanical and electrical specifications, dimensional drawings, etc. of the FR-2LE.

## Manual conventions

This manual is described according to the following conventions.

1. **The following abbreviations are sometimes used.**

**<Examples>**

CompactFlash™ card	->	CFC
Sampling frequency	->	FS
Realtime clock	->	RTC
Personal computer	->	PC

2. **The names of keys, switches and connectors of the FR-2LE used in this manual match their labels on the panel.**

**<Examples>**

Playback key	->	the [PLAY] key
Power switch	->	the [POWER] switch
Analog input connectors	->	the [ANALOG IN] connectors

3. **The on-screen messages and switch position names are surrounded by " ".**
4. **The on-screen messages and items, as well as the indicators on the panel, "light" or "flash".**
5. **"Notes" give a tip or advice for using the FR-2LE powerfully and skillfully.**

# Chapter 1: Product overview

This chapter describes the product overview, main features/functions, supplied accessories and how to update the software.

## Overview

The Model FR-2LE is a portable two-track field memory recorder for professional use, which records audio to a Type 2 CompactFlash™ card. You can make high quality recording either in stereo.

Designed specifically for location recording, the FR-2LE is a portable and light-weighted machine, offering simple and easy-to-use operation. You can operate the FR-2LE with batteries or on the supplied AC adaptor.

The FR-2LE provides of USB port for PC connection. By making PC connection, you can easily transfer audio files from the FR-2LE to a PC and edit the files on it.

## Main features

- Provides a card slot for Type 2 CompactFlash™ cards. You can use a CompactFlash™ card for recording.
- Two ways to supply the power to the unit; batteries (alkaline, Ni-Cd, Ni-MH batteries) and the supplied AC adaptor. Also you can use the world standard Tamiya battery for long time recording.
- Supports the FAT32 file system. The Broadcast Wave File (BWF) recording file format (interleave 1 file mode) is used, which enables exporting files to a DAW such as Pro Tools.
- Supports a variety of sampling frequencies/quantization bits. 24-bit at 44.1 kHz, 48 kHz, 88.2 kHz and 96 kHz. 16-bit at 44.1 kHz and 48 kHz. Also you can record an audio file in MP3 format.
- The "Pre Record" function, a useful feature for location recording, enables FR-2LE to constantly store up to approximately 2 seconds of audio to the internal buffer. When you start recording, the previous data is first delivered from the buffer (you can select on or off for the "Pre Record" function from the Setup menu in the MENU mode).
- Provides the trim control for each of left and right channels independently. You can also supply the +48V phantom power to a condenser microphone which requires the power (you can select on or off for the phantom power from the Setup menu in the MENU mode).
- 132 x 64 highly visible, low power consumption, backlit dot matrix LCD display shows various information.
- USB port for PC connection. By connecting a PC directly, you can transfer audio files (WAV files and MP3 files) between the FR-2LE and the PC.
- You can set a marker (cue point) at a desired point during recording (up to 99 cue points can be set per file). You can locate to a desired cue point quickly.
- Supplies the wired remote control unit, allowing you to control the unit remotely.
- The error tone can be generated to warn you when the battery voltage drops down to the specific level, or when the remaining recording time of the memory card gets short (you have to set the associated menu item appropriately).



## Supplied accessories

Make sure that the box contains the following accessories. If any of them are missing, please contact your Fostex dealer.

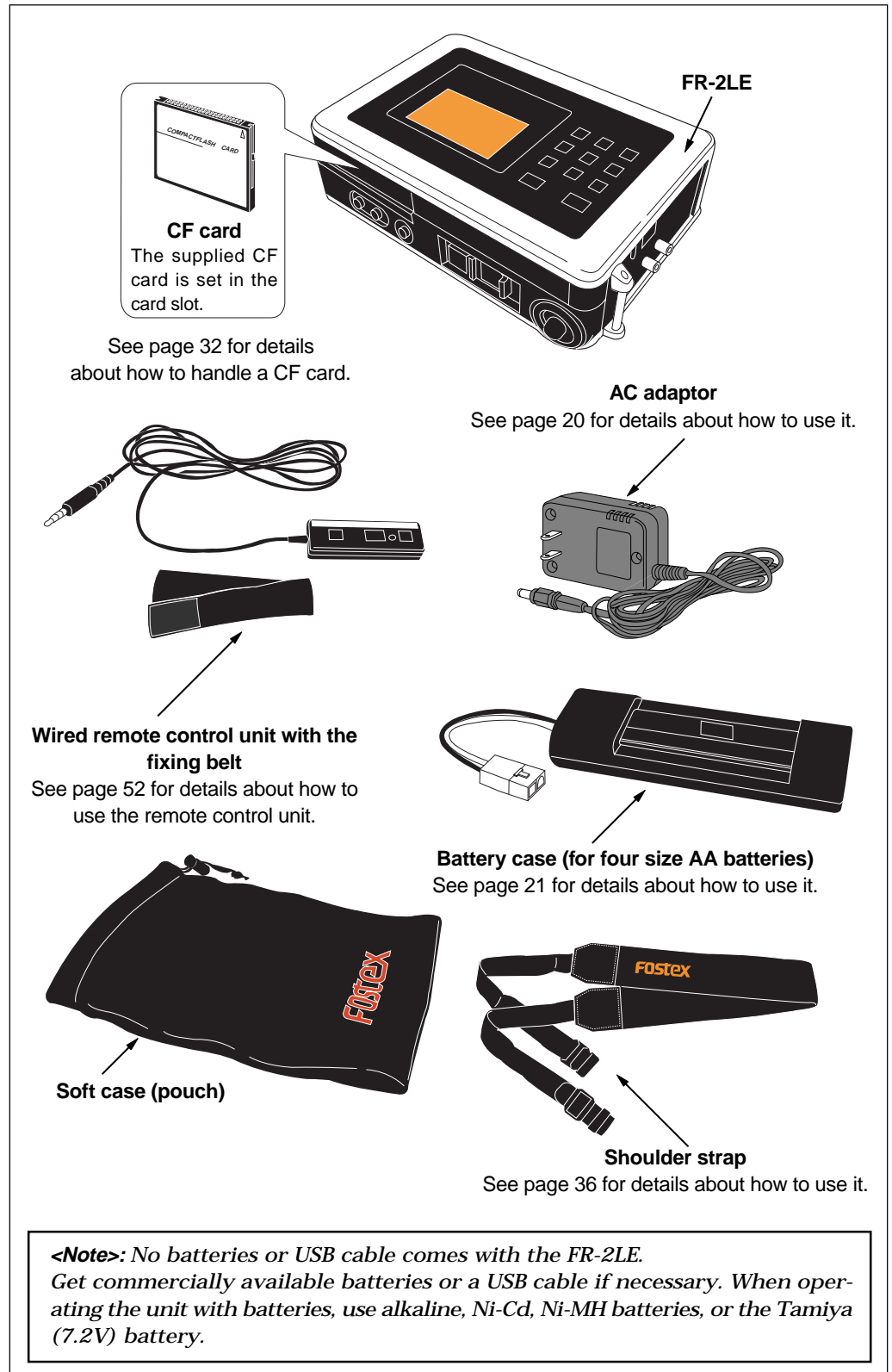

## About software update

The software of the FR-2LE may be updated in the future.

To get the information about the latest software version, visit the Fostex web site (<http://www.fostexinternational.com>) or ask your local Fostex dealer or service station.

You can download the latest software via the Fostex web site and update your FR-2LE by following the procedure below (see the reference pages for details).

**<Note>**: If you cannot download the software from the Fostex web site, ask your local Fostex dealer or service station.

- (1) Access the Fostex web site (<http://www.fostexinternational.com>) and download the updated software for the FR-2LE to your personal computer.

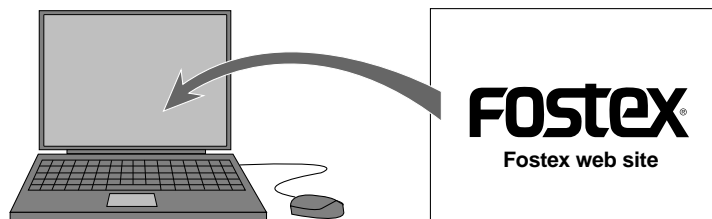

- (2) Connect your FR-2LE to your personal computer, and copy the downloaded software to the memory card on the FR-2LE.

See pages 70 and 71 for details about connection. See page 72 for details about copying.

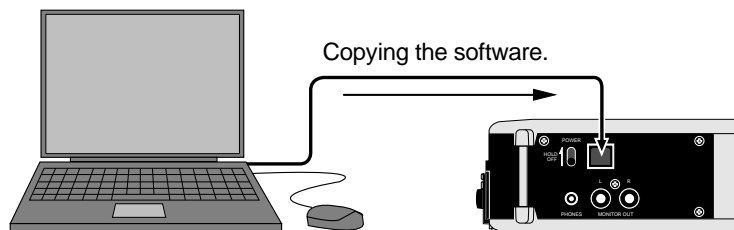

- (3) Disconnect the FR-2LE from the personal computer, and upgrade the FR-2LE using the "Version Up" item on the "Setup" mode in the MENU mode.

See page 111 for details about operations of the "Version Up" item.

```
MENU▶Setup▶Version UP
Battery Type : NiHM
Error Tone :Off
AdjustRealTimeClock▶
Version ▶
Initial Setup▶
▶Version UP▶
```

← "Version up" item

"Setup" menu screen in the MENU mode

# Chapter 2: Before using the FR-2LE

## < Please read this chapter before using >

This chapter describes details about power supply for operating the unit and memory cards for recording. Please read this chapter thoroughly before using the unit so that you can supply the power to the unit properly, as well as make recording smoothly. Especially, read the description of how to format a memory card carefully before using a new card.

### <Table of contents>

<b>About power supply .....</b>	<b>20</b>
Operating the FR-2LE on AC adaptor .....	20
Connecting the AC adaptor .....	20
Operating with batteries .....	21
Inserting four size AA batteries to the battery case .....	21
Setting the battery case (or The Tamiya battery) to the unit .....	22
Reducing the battery power consumption .....	24
Turning on the power .....	25
Battery remaining indication .....	26
<b>Formatting a memory card .....</b>	<b>27</b>
<b>Setting the display backlight/contrast .....</b>	<b>29</b>
Turning the backlight on or off .....	29
Adjusting the display contrast .....	30
<b>About the internal realtime clock .....</b>	<b>31</b>
<b>About memory cards .....</b>	<b>32</b>
Inserting/removing a memory card .....	32
Removing a memory card .....	33
Inserting a memory card .....	34
<b>How to attach the shoulder belt to the unit .....</b>	<b>36</b>

## About power supply

The FR-2LE is powered either by the supplied AC adaptor or by four AA-type batteries (alkaline, Ni-MH or Ni-Cd) or the Tamiya battery.

**<Note>**: Make sure that the FR-2LE power switch is set to "OFF" when changing batteries or when disconnect the AC adaptor from the unit. The unit continuously accesses data when the power is on, so the memory contents may be reset by the sudden power interruption.

**<Notes>**

- Supplying excessive voltage may damage the unit. Never supply voltage which exceeds the regular voltage.
- If batteries are completely exhausted or the power supply section has a trouble by surge current, etc., the protection circuit works and the power is shut off. In such a case, set the [POWER] switch to "OFF", replace batteries with new (or fully-charged) ones, then set the [POWER] switch to "ON" again.  
If the FR-2LE does not return to the normal condition after carrying out the procedure above, there may be some trouble inside the circuit. In such a case, consult your local Fostex dealer or service station.

## Operating the FR-2LE on the AC adaptor

To operate the FR-2LE on an AC adaptor, use the supplied AC adaptor.

**<Notes>**: Use only the supplied AC adaptor. Using another AC adaptor may damage the FR-2LE due to the mismatch of the power voltage, polarity, etc.  
When connect or disconnect the AC adaptor, make sure that the [POWER] switch is set to "OFF".

### • Connecting the AC adaptor

While the [POWER] switch of the FR-2LE is set to "OFF", connect the AC adaptor to the [DC IN] jack on the left side panel of the FR-2LE, and then to the AC main outlet.

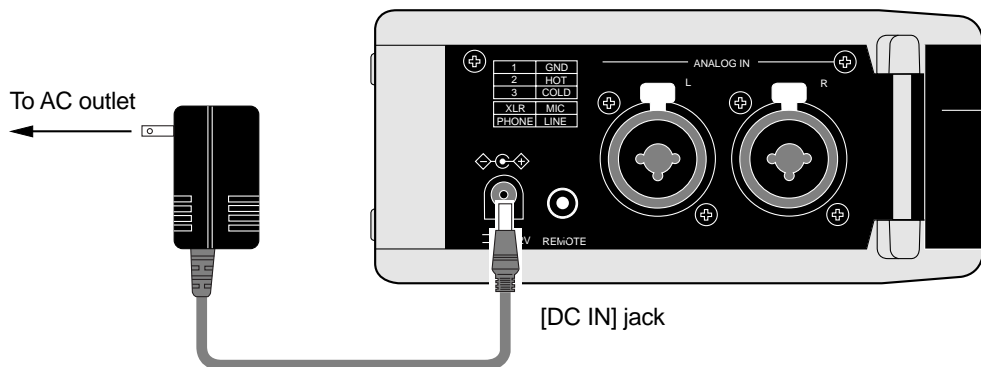

**<Notes>**: Do not unplug the AC adaptor while the FR-2LE is accessing a memory card (i.e. during recording, playback, etc.). Turning the power off suddenly may damage recorded data or the memory card.

## Operating with batteries

To operate the FR-2LE with batteries, insert four commercially available AA alkaline, Ni-Cd or Ni-MH batteries to the supplied battery case and set it to the unit, or set a Tamiya battery to the unit.

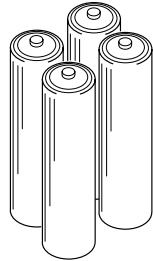

Alkaline, Ni-Cd, or Ni-MH batteries

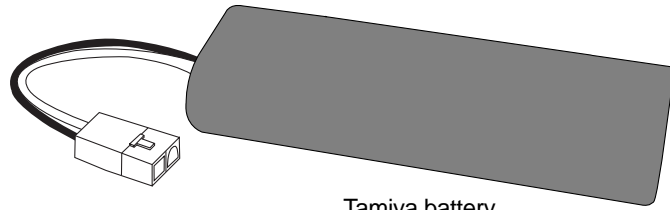

Tamiya battery

### <Notes on using batteries>

- When you operate the unit on commercially available AA batteries, use alkaline, Ni-Cd, or Ni-MH batteries. Do not use manganese batteries.
- Use new batteries (or fully charged batteries) when replacing batteries.
- Do not mix old and new batteries together.
- Do not use leaked batteries.

### <Notes on using rechargeable Ni-Cd/Ni-MH batteries or a Tamiya battery>

The FR-2LE does not provide battery charging facility. To charge rechargeable Ni-Cd, Ni-MH batteries or a Tamiya battery, use an appropriate battery charger for the battery type and follow the instructions of the charger to fully charge batteries.

### <Important! (Do not forget to make the following setting.)>

After setting (or replacing) AA batteries and turning on the FR-2LE, be sure to select the battery type (Ni-MH, Ni-Cd, Alkaline or Tamiya battery) to match the batteries inserted using the "Battery Type" menu item on the Setup menu in the MENU mode. If the batteries in the battery compartment do not match the battery type setting, the error tone function, etc. may not work correctly because of the voltage difference. See page 107 for details about how to set the battery type.

**<Note>**: When you set the Tamiya battery to the unit, the unit automatically detects it and sets the "Battery Type" item to "RC7.2V". When you replace the Tamiya battery with size AA batteries (alkaline, Ni-Cd, or Ni-MH), set the "Battery Type" item manually to the appropriate option. If you use size AA batteries while the "Battery Type" item is set to "RC7.2V", the unit generates the alarm to minimize damaging the batteries. To stop the alarm, set the "Battery Type" item appropriately.

## Inserting four AA batteries to the battery case

Insert four AA batteries to the supplied battery case. Make sure that the batteries are the right way round (+ and -), as shown below.

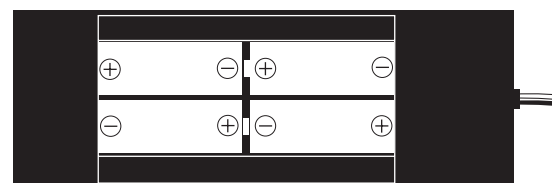
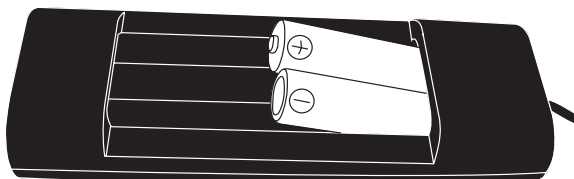

**Setting the battery case (or a Tamiya battery) to the unit**

- 1) **Remove the compartment cover on the bottom panel of the FR-2LE.**  
Pull the hook in the arrow direction and lift the cover.

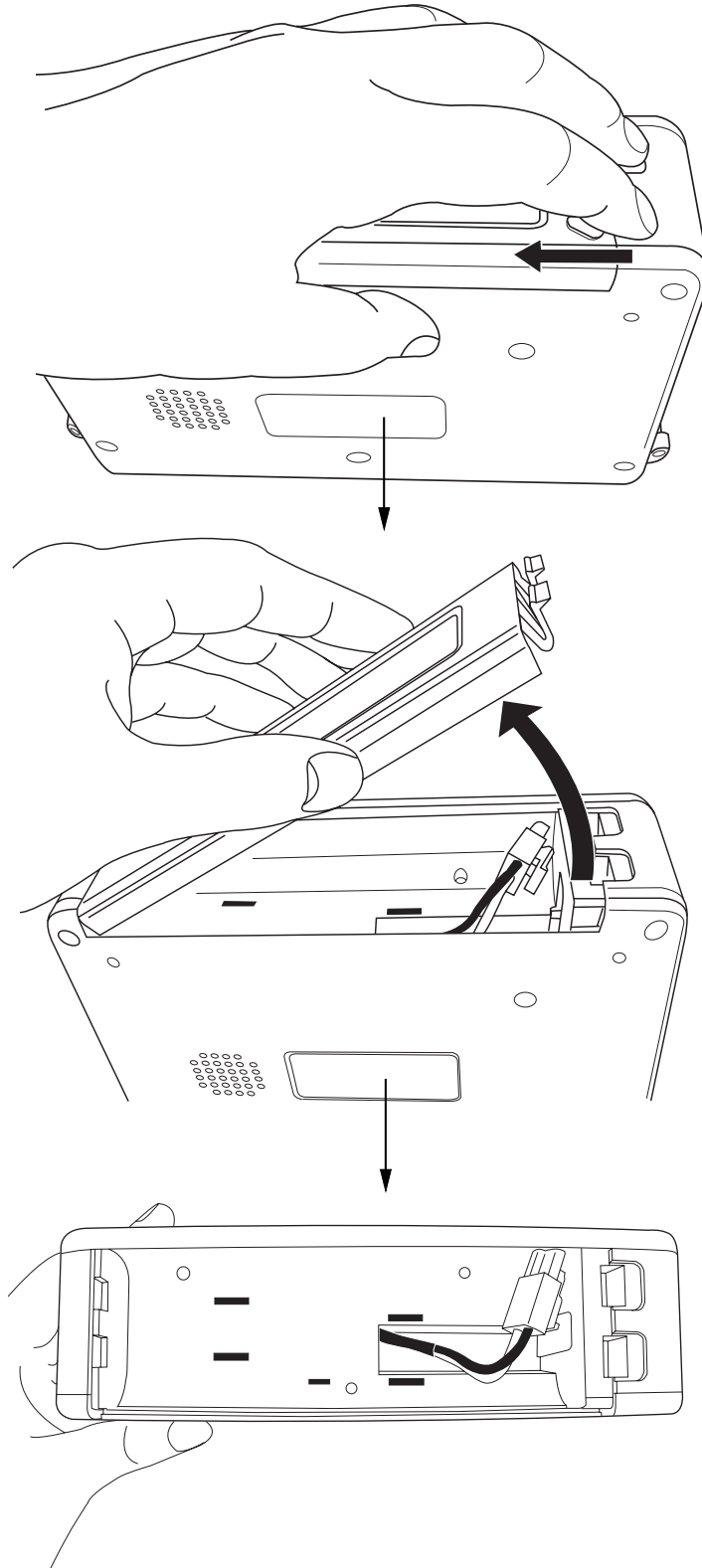

- 2) Connect the cable of the battery case (or a Tamiya battery) to the connector of the FR-2LE.

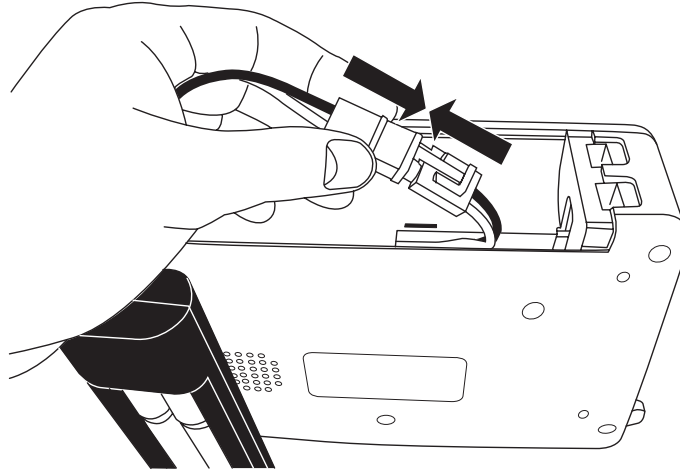

- 3) After making cable connection, insert the battery case (or a Tamiya battery) to the compartment.

There is a space in the compartment for placing the cable (as indicated by the arrow in the figure below). Insert the battery case (or a Tamiya battery) to the unit while putting the cable in the space (see the figure below).

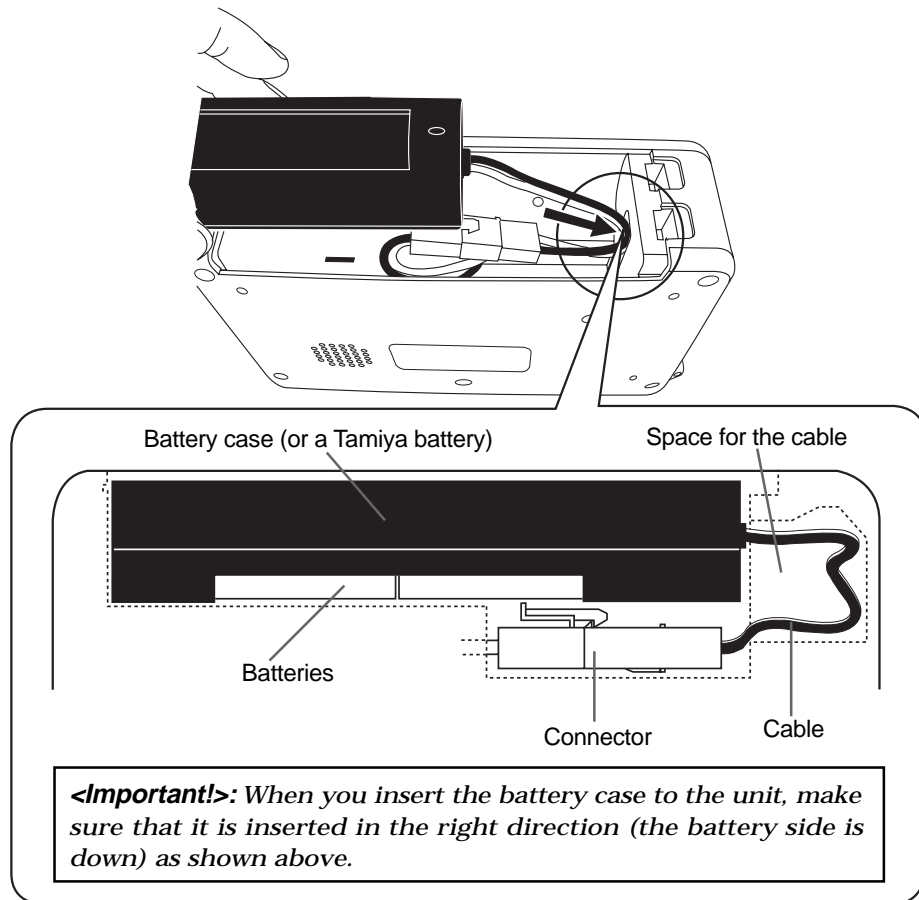

**<Note>** When you insert the battery case (or a Tamiya battery) to the unit, make sure that the cable is not trapped between the battery case and connector.

- 4) After inserting the battery case (or a Tamiya battery) to the unit, close the compartment cover.

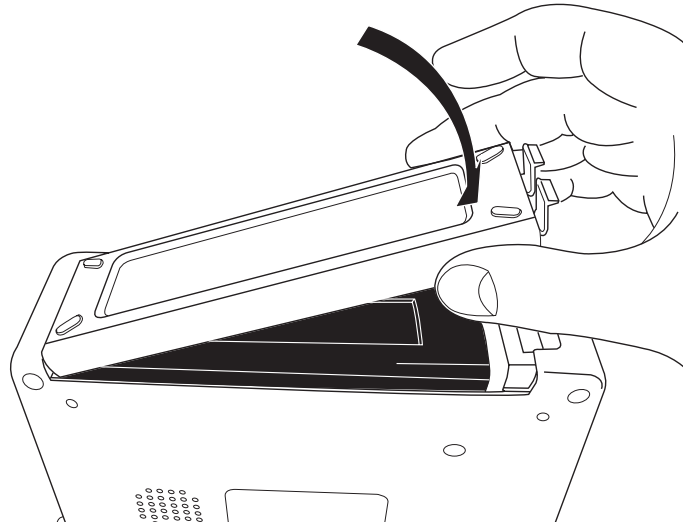

**<Note>**: Wipe terminals of the battery case and batteries with a dry cloth on occasion. If terminals are dirty, the voltage supplied to the unit may drop down.

**<Note>**: Used batteries should be disposed following to your local regulations to avoid problems of environmental pollution.

The chart below shows the expected battery life of continuous operation by type. Note that it depends on the circumstance the FR-2LE is used (temperature, humidity, the number of recordings) and battery manufacturers, therefore, use the chart just for your reference.

The FR-2LE can indicate remaining battery life, as well as can generate the error tone when the power voltage drops down to the specific level. See "Battery remaining indication" on page 26 for details about the voltage indication, and see page 107 for details about error tone output.

Ni-MH (4.8V)	Alkaline (6V)	Tamiya Battery (7.2V)
approx. 4 hours (using 2150 mAh)	approx. 4 hours (using 2300 mAh)	approx. 8 hours (using 3600 mAh)

**• Reducing the battery power consumption**

The following shows tips for reducing battery power consumption to extend the battery life.

- The lower the input impedance of a device connected to the FR-2LE's output connectors (MONITOR OUT), the less battery power the unit consumes.
- The lower the output level of headphones or internal monitor speaker, the less power consumption.
- If you do not use the unit for a long period of time, you should remove batteries (when batteries are inserted, the unit consumes little power even though the [POWER] switch is set to "OFF").



## Turning on the power

By setting the [POWER] switch to "ON" after inserting batteries or connecting the AC adaptor, the unit starts up. The following is assumed that a CompactFlash™ card is set to the card slot as when the unit is shipped.

**<Note>**: The [POWER] switch is of the "momentary type", therefore, when turning off the power, you move it to the same direction as when turning on the power. To turn off the power, hold the switch up for two seconds.

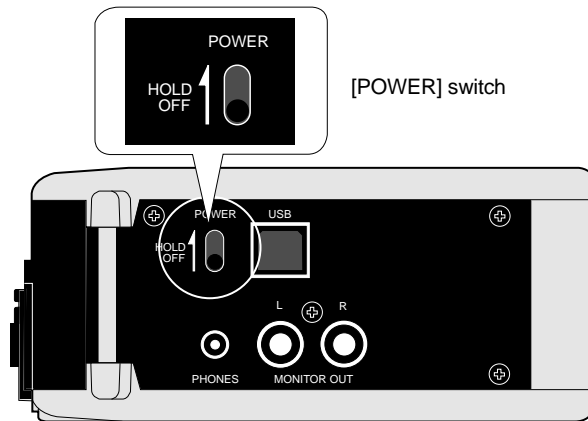

When the FR-2LE is shipped, a 128MB CompactFlash™ card is set to the card slot.

Therefore, if you turn on the unit in this condition, the following message appears when the unit is booted up. This message appears when an unformatted card is set to the card slot. So you need to format the card before using. See "Formatting a memory card" on page 27.

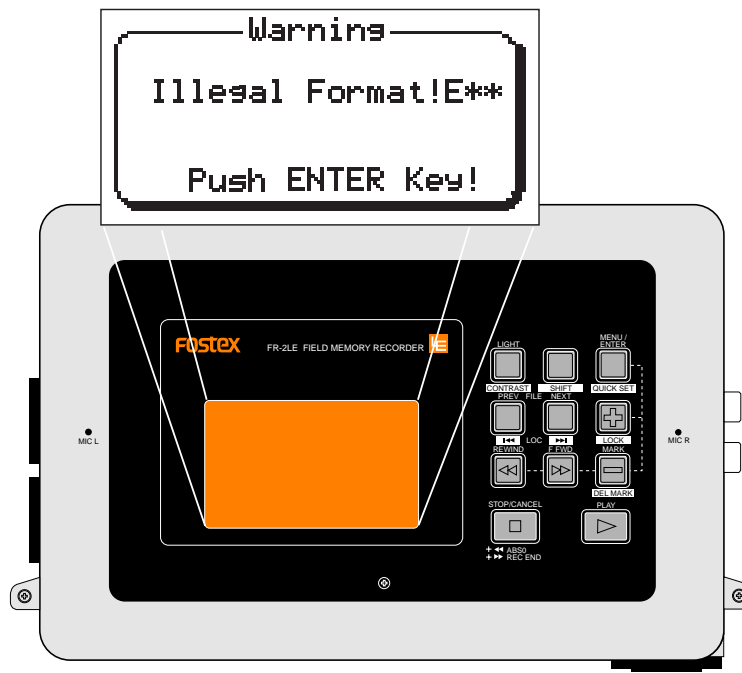

### Battery remaining indication

When the FR-2LE operates with batteries, you can roughly know the battery condition via the battery indicator at the bottom of the display. We recommend paying attention to the battery indicator in order not to miss the timing of battery change.

Note that the battery indicator does not show the condition precisely, therefore regard it as a rough guide.

		Adequate battery power remains.
		Battery power remains half.
		You should replace batteries.

<p><b>&lt;Note&gt;</b>: If you continue to use the unit after the "BATT" indicator gets shorter and batteries are exhausted, the display shows the warning message as shown right and the unit automatically shuts down. When operating the unit with batteries, you should always pay attention to the battery power condition.</p>	
--	--

In addition to the battery indicator, the FR-2LE provides the error tone function which generates the error tone from the internal monitor speaker (or from headphones output) when the battery power drops down to a certain level.

You can make the error tone output setting from the "Error Tone" menu item on the "Setup" menu in the "MENU mode". See "Setting error tone output condition" on page 107.

## Formatting a memory card

The FR-2LE accommodates memory cards formatted with the FAT32 file system. When you use an unformatted memory card or a card which is formatted with a file system other than FAT32, format it by the following procedure. In the following procedure, it is assumed that a non-FAT32 formatted card is loaded, and the display shows the warning message ("Illegal Format!").



- 1) **While the warning message is shown, press the [MENU/ENTER] key.**  
 The display automatically changes to show the "Format" menu item on the "Disk" menu, as shown below.  
 You can select a reel number and recording format (FS/BIT mode) of the memory card to be formatted. In the following example, it is assumed that you do not change the reel number and only set the recording format.  
 You can also edit the reel number after formatting a card (see page 97 for details).

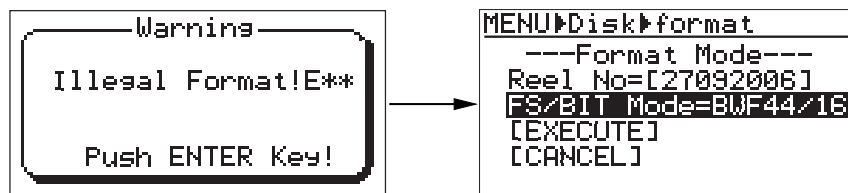

- 2) **While "FS/BIT Mode=\*\*\*\*/\*" is highlighted, press the [MENU/ENTER] key.**  
 The current recording format starts flashing and you can now make selection (the default format is "BWF44/16").

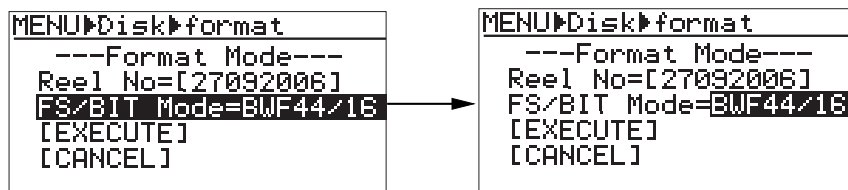

By pressing the [+] or [-] key while the current recording format is flashing, you can select the desired recording format. The available options are listed on the following table.

<b>BWF44/16</b>	44.1kHz/16 bit, BWF file mode.
<b>BWF44/24</b>	44.1kHz/24 bit, BWF file mode.
<b>BWF48/16</b>	48kHz/16 bit, BWF file mode.
<b>BWF48/24</b>	48kHz/24 bit, BWF file mode.
<b>BWF88/24</b>	88.2kHz/24 bit, BWF file mode.
<b>BWF96/24</b>	96kHz/24 bit, BWF file mode.
<b>MP3-192</b>	MP3 192 kbps compressed file mode.

**<Memo>**  
**BWF:** BWF stands for "Broadcast Wave Format" and is a standard audio format created by the EBU (European Broadcasting Union). You can exchange BWF audio data between computers and audio workstations.  
**MP3:** MP3 stands for "MPEG-1 Audio Layer3" and is a compressed audio format. The compression ratio of MP3 is relatively high. For example, an audio data which requires 500MB when it is recorded in the BWF format can be compressed to 70MB when it is recorded in the MP3 format.

\* For the recording time on a card after formatting, see page 54.

- Use the [+ ] or [- ] key to select the desired recording format, and press the [MENU/ENTER] key. The selected recording format is confirmed and the display returns to the previous screen.
- Use the [- ] key to move the cursor to "[EXECUTE]" and press the [MENU/ENTER] key. The display now shows the following warning message. If you do not format the card, select "[CANCEL]" and press the [MENU/ENTER] key.

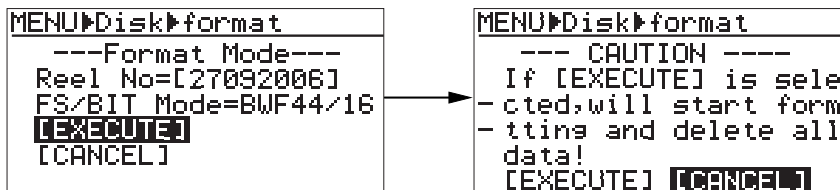

- Use the [REWIND] key to move the cursor to "[EXECUTE]" and press the [MENU/ENTER] key. The unit starts formatting. When formatting is successfully completed, "Success." is shown and the unit stops accessing the card.



- Press any operation key of the unit. The display now shows the Home screen. The following example shows the Home screen which appears after formatting with "BWF48/16" recording format.

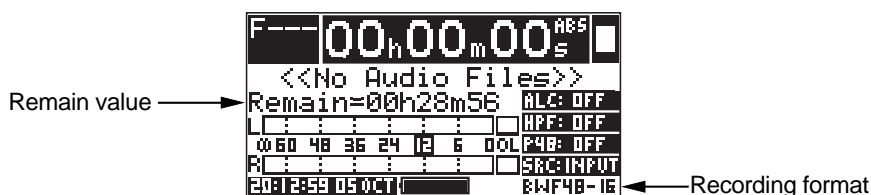

On the screen after formatting is completed, "<<No Audio Files>>" is shown on the screen. This indicates that no audio file exists on the card.

Also the remaining (recordable) space of the card is shown on the screen.

By default, remaining space is shown by the recordable time value (in the example above, "00h28m56"). You can see the remaining space by "MB", which can be set via the "Remain Display" menu item on the Setup menu in the MENU mode (see page 104 for details).

You can now make recording to the formatted memory card using the FR-2LE. For details, see "Chapter 5: Recording/playback" starting from 53 pages.

## Setting the display backlight/contrast

According to the situation, you can turn the display backlight on or off, as well as adjust the display contrast.

### Turning the backlight on or off

By pressing the [LIGHT/ CONTRAST] key on the front panel, the display backlight turns on for three seconds and then automatically turns off.

By pressing and holding the [LIGHT/ CONTRAST] key for more than two second, the backlight turns on and keeps lighting. To turn off the backlight, press the [LIGHT/ CONTRAST] key again.

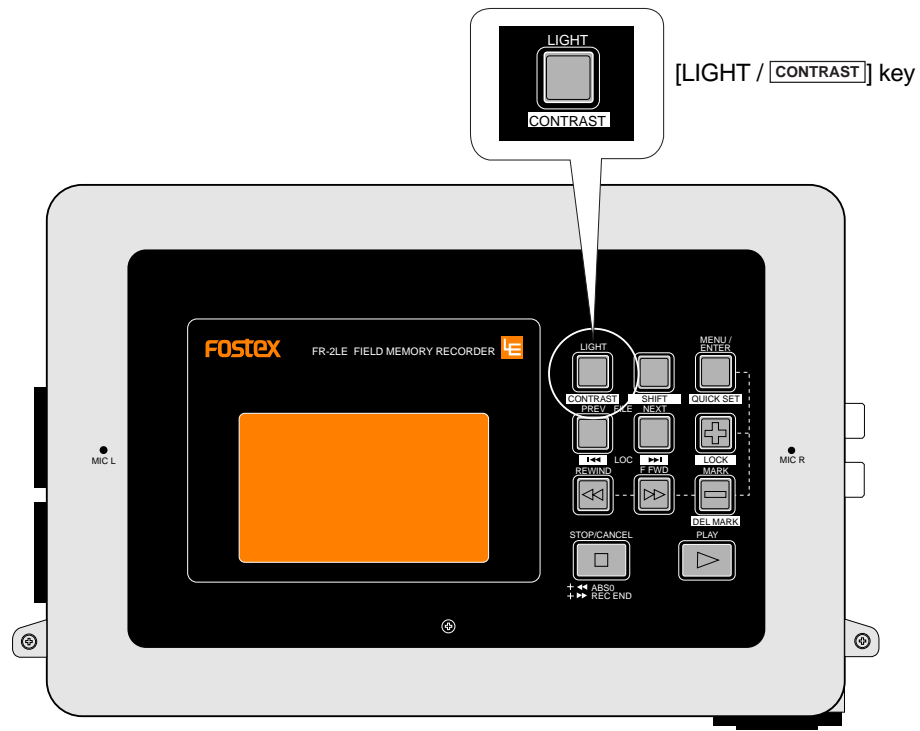

**<Note>:** When operating the unit on batteries, to save the battery power, we recommend not keeping the backlight lighting unless it is necessary.

## Adjusting the display contrast

You can adjust the display contrast by following the procedure below.

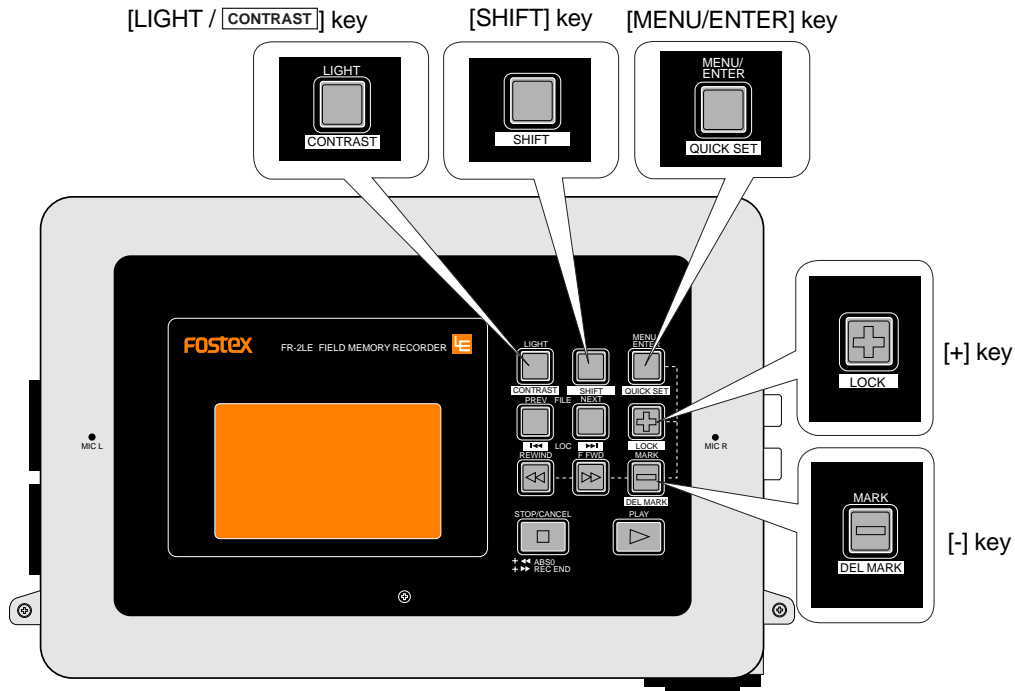

- 1) When the recorder is stopped, press the [LIGHT / CONTRAST] key while holding down the [SHIFT] key.  
The following popup screen appears on the display.

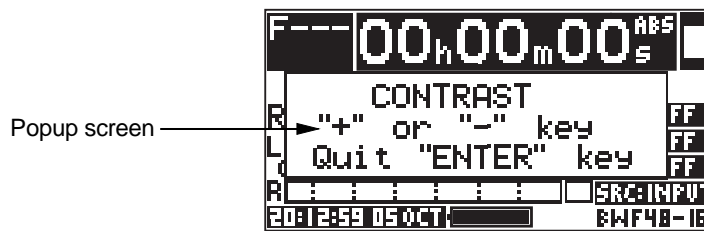

- 2) Use the [+] and [-] keys to adjust the display contrast.  
Pressing the [+] key strengthens the contrast, while pressing the [-] key weakens the contrast.
- 3) After adjusting the contrast, press the [MENU/ENTER] key to fix the contrast value.  
The display returns to show the previous Home screen, while the selected contrast value is stored to the Flash ROM.

## About the internal realtime clock

The FR-2LE offers the internal realtime clock. The current time data of the realtime clock is shown on the display.

The time data of the realtime clock can be used as a file name when a new audio file is created on the card (i.e. the file name shows the creation date/time of the file) or a time stamp on the BWF file.

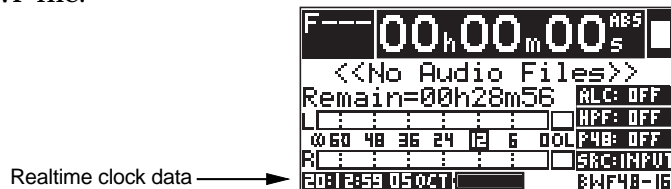

**<Notes>**: By default, the realtime clock is adjusted to the local time of the factory when shipped. Therefore, set the time to your local time before using the unit. You can adjust the realtime clock via the "Adjust Real Time Clock" menu item on the "Setup" menu in the MENU mode. See "Adjusting the real time clock" on page 108 for details.

**<Notes>**: By default, when an audio file is created, the realtime clock data is automatically used as the file name (we call it "default file name"). The file name is shown on the display as in the example below (pointed by the arrow). You can select the default file name between "realtime clock data", "scene name + take number" and "Reel Number + File Number" from the "File Name Mode" menu item on the "Setup" menu in the MENU mode. Also, when the "scene name + take number" option is selected in this menu item, you can set the desired scene name and take number using the "Default Scene Name" menu item on the "Setup" menu in the MENU mode.

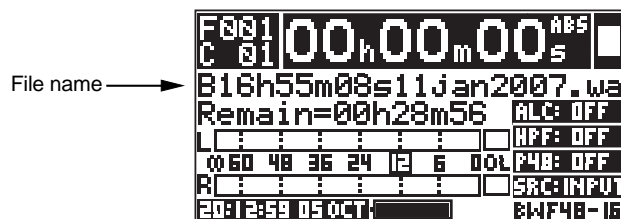

\* See "Selecting default file name type" and "Setting the default scene name" on pages 98 through 101.

**<Note>**: The FR-2LE is equipped with a lithium battery which operates the realtime clock. Normally, the battery life is approximately four or five years. When battery voltage drops down to a certain level, the following warning message appears (the warning message can be dismissed by pressing the [MENU/ENTER] key). If this warning message appears, ask your local Fostex dealer or service station for replacing the lithium battery (the battery cannot be replaced by a user).

Warning  
RTC Battery Empty!  
Push ENTER Key!

## About memory card

The FR-2LE is equipped with a CompactFlash™ card slot which accepts a Type 2 CompactFlash™ card. (When the unit is shipped, a 128MB CompactFlash™ card is set to the slot.)

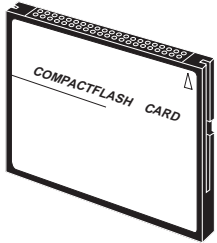

CompactFlash™ card

**<Note>**: A virgin memory card which is FAT32 formatted can be used without the need of initial-formatting, however, we recommend formatting such a card using the "Format" menu item on the "DISK" menu in the MENU mode. Also, if you use a FAT32 formatted memory card which has been used with a PC, we recommend formatting it in the same manner. For details about formatting a card using the "Format" menu item on the "Disk" menu, see page 86.

## Inserting/removing a memory card

A memory card should be inserted to the card slot on the front panel of the unit. Open the protection cover and insert a card to the slot. You can see the eject button beside the slot.

**<Note>**: When you insert a memory card to the card slot or remove it from the card slot, make sure that the unit is powered off. If you insert or remove a memory card while the unit is powered on, the card may be damaged or data may be destroyed. Also be sure to insert a card in the correct direction and side.

**Note that Fostex is not responsible for any damage of a card caused by incorrect card handling.**

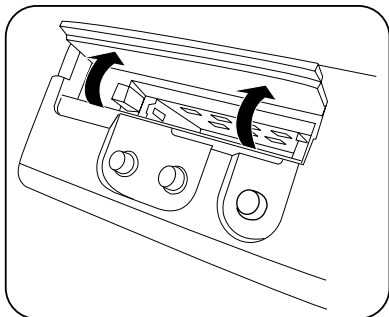

When opening the slot protection cover on the front panel, you can see the slot and eject button inside.

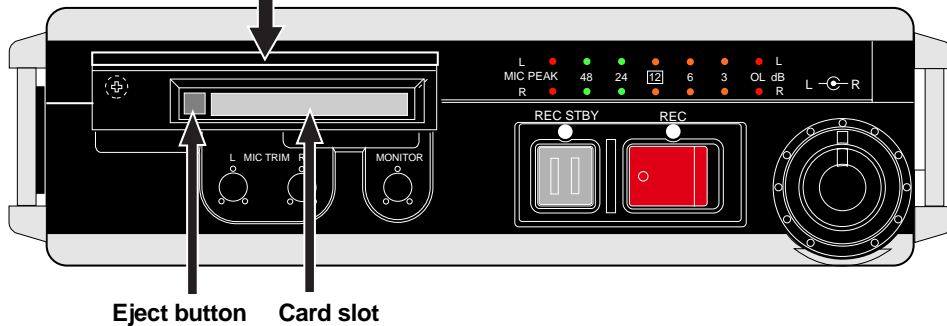



• **Removing a card**

The following describes how to remove a memory card from the slot. It is assumed that a memory card (regardless of whether it is the supplied memory card or another one) is inserted to the slot.

**<Note>:** When you remove a memory card from the slot, make sure that the unit is powered off.

- 1) **While the power is off, open the protection cover and press the eject button.**  
The eject button is "2-position" type, and when you press it once, the button is raised.

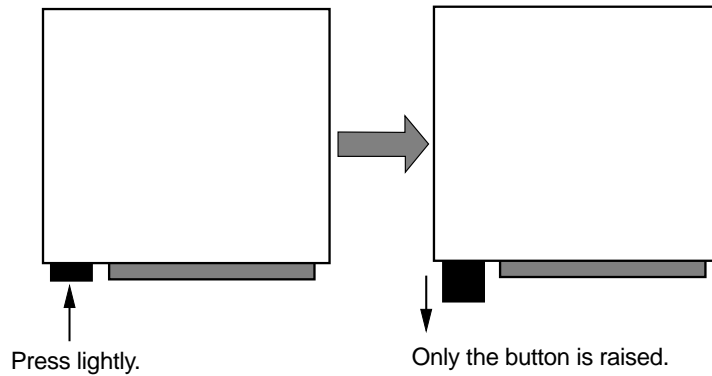

- 2) **Press down the eject button again (to depress the button).**  
The memory card is ejected from the slot. Take out the card by hand.

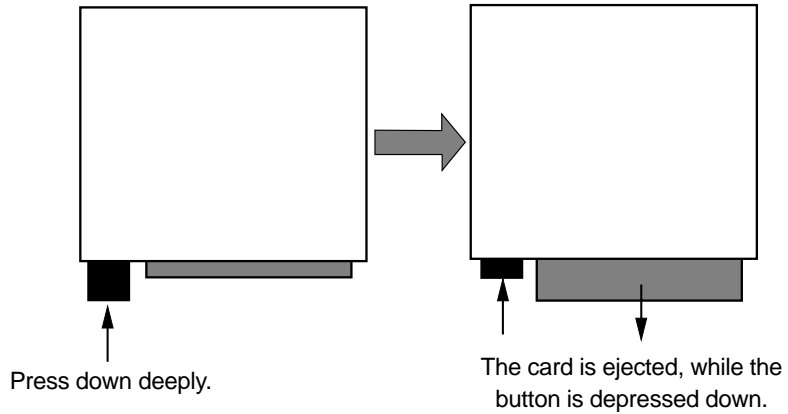

If you turn on the unit after removing the card, the display shows "<<No Disk>>".



• **Inserting a card**

The following describes how to insert a memory card to the slot. In the following description, it is assumed that the unit is powered off.

**<Note>**: If you set a card while the eject button is in the up position, you cannot close the protection cover. If you depress the eject button in this case, the card is ejected. Therefore, when you attempt to insert a memory card to the slot, make sure that the eject button is depressed. If it is in the up position, press it down before you insert the card to the slot.

- 1) **Insert the memory card to the card slot, and turn on the power.**  
If you turn on the power after you insert the card, the appropriate screen as described below is shown depending on the card condition.

**<Note>**: Be sure to insert a memory card firmly in the correct direction.

• **When an unused formatted card is set**

The display shows the Home screen as below. "<<No Audio Files>>" indicates that no recording has been made to the card.

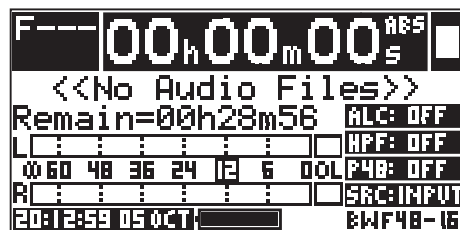



**How to attach the shoulder belt to the unit**

The supplied shoulder belt should be attached to the unit correctly as shown below. Otherwise, the unit may fall down, resulting in human injury or damage of the unit.

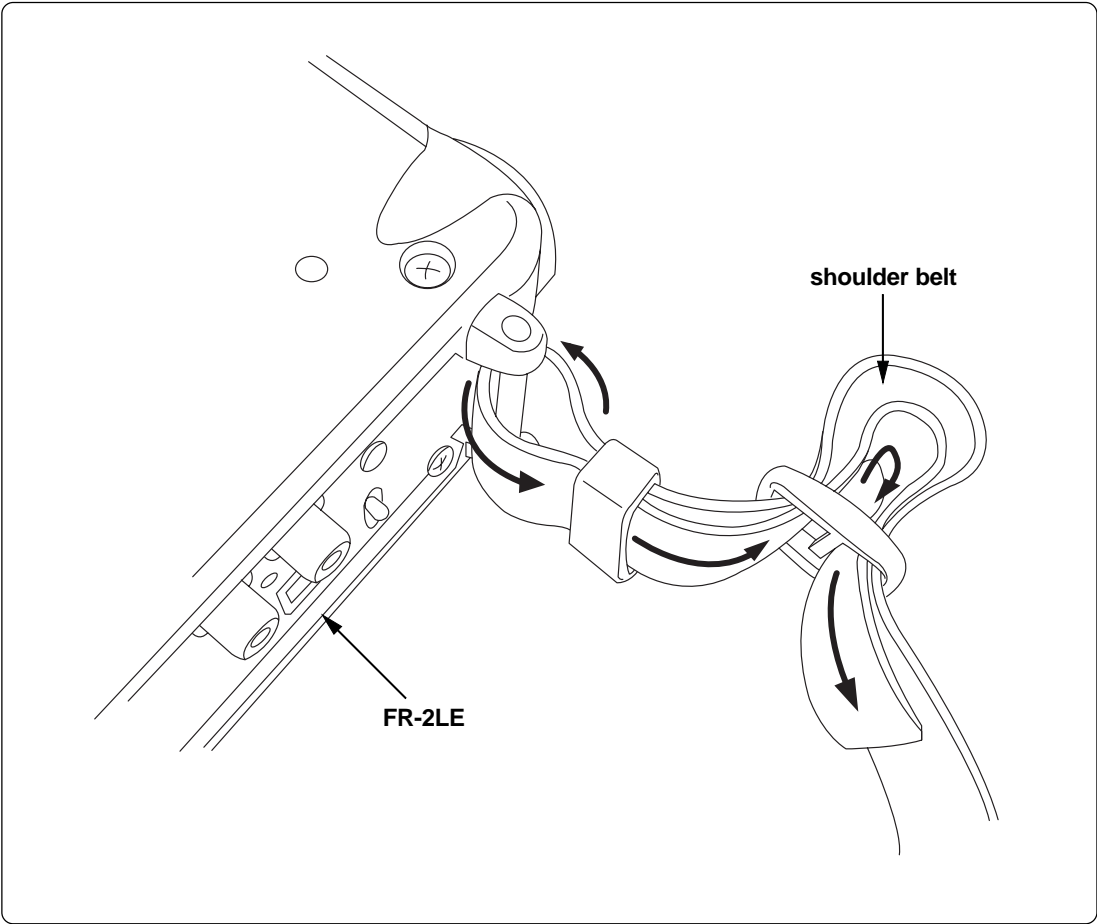

## Chapter 3: Names and functions

### <Table of contents>

Front panel .....	38
Top panel .....	39
Left side panel .....	41
Right side panel .....	42
Back panel .....	42
Bottom panel .....	43
Details about screens .....	44
Home screen .....	44
When no memory card is set .....	44
When a formatted blank memory card is set .....	44
When a recorded memory card is set .....	44
MENU mode screens .....	46
Warning message screen .....	46

## Front panel

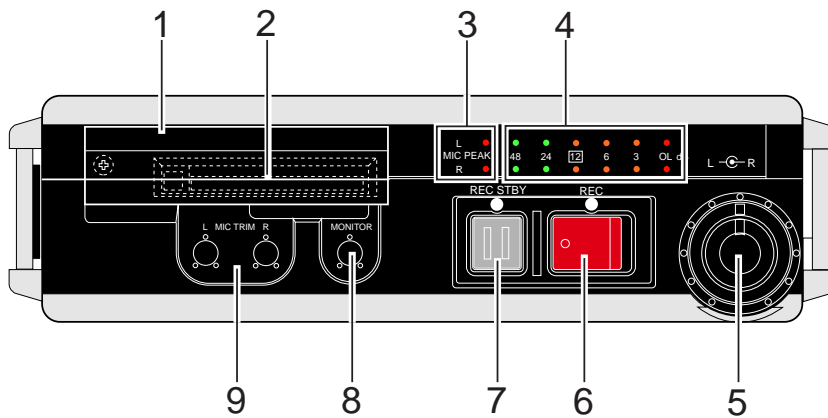

- 1) **Slot protection cover**
- 2) **Card slot and Eject button**

You can insert a compact flash card™ to the card slot.  
To remove the card, press the eject button. See "About memory cards" on page 32 for details.
- 3) **[MIC PEAK] indicators**

When the input signal from the [ANALOG IN] XLR connector is too hot, the corresponding [MIC PEAK] indicator lights up. When you record a signal received from the [ANALOG IN] XLR connector, adjust the [TRIM] control so that the corresponding [MIC PEAK] indicator does not light.
- 4) **Level meters**

Displays recording or playback levels.
- 5) **Recording level controls**

Adjust recording levels (L and R) of external microphone or line input sources.  
These controls are not effective for the internal microphone.
- 6) **[REC] (Record) key**

Pressing this key starts recording.  
Each time you press this key, a new audio file is created.  
When the PRE REC mode is set to "ON", the previous data stored in the buffer (two seconds) is also recorded.
- 7) **[REC STBY] (Record Standby) key**

Before recording, pressing this key makes the unit record-standby and input monitor.  
Pressing this key again releases input monitor.  
During recording, pressing this key stops recording (you can also stop recording using the [STOP/CANCEL] key).
- 8) **[MONITOR] control**

Adjusts the output level of [PHONES] and [MONITOR OUT] connectors, as well as the monitor level of the internal monitor speaker.  
Do not monitor the sound for a long period of time at a high volume level, since this can cause permanent hearing.

9) **[MIC TRIM] controls**

These controls adjust the input levels of external microphone received from the [ANALOG IN] XLR connectors within the range between -50dBu and -10dBu.

These controls are not effective for the internal microphones or line inputs received from the [ANALOG IN] phone connectors.

**Top panel**

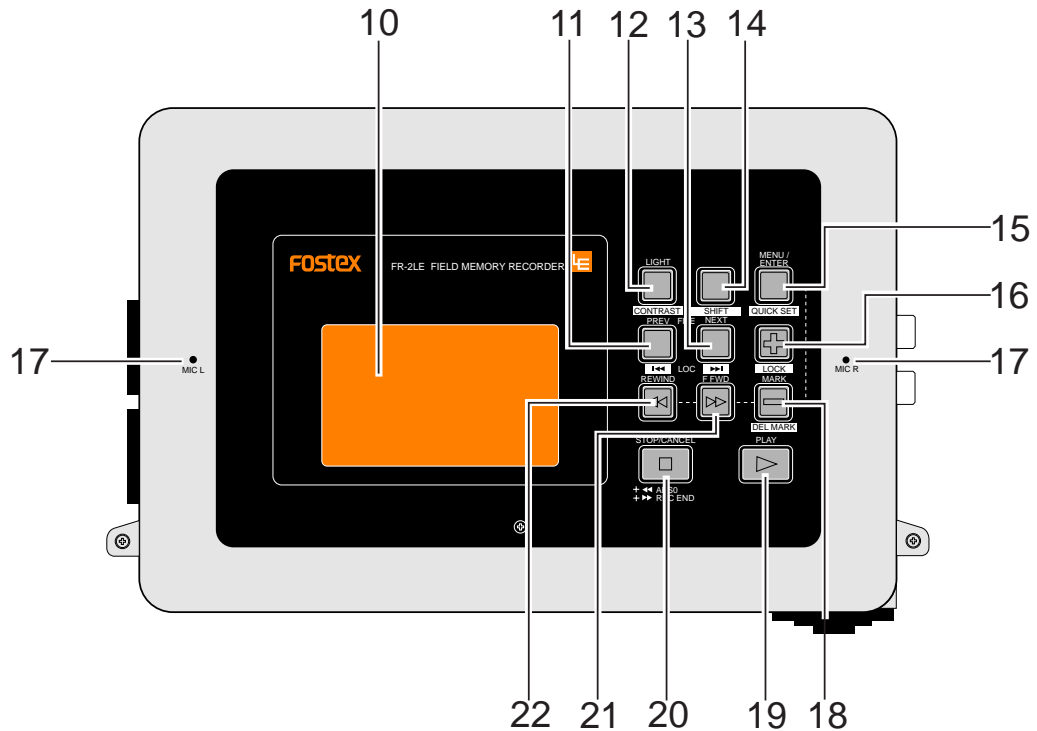

10) **LCD display**

Displays various kinds of information including audio input/output levels, current settings, etc. See "Details about screens" on page 44 for details.

11) **[FILE PREV] / [LOC <<<] key**

When more than one audio file exists on the card, pressing this key switches the current file to the previous entry in the list.

If any cue points (CUE 01 through 99) are stored in the current file, pressing this key while holding down the [SHIFT] key skips back to the previous cue point.

12) **[LIGHT / CONTRAST] key**

By pressing this key briefly, the backlight of the display lights for three seconds and then automatically turns off.

By pressing down this key for more than two second, the backlight turns continuously on. To turn off the backlight in this condition, press this key again.

**<Note>**: When operating the unit on batteries, to save the battery power, we recommend not to keep the backlight continuously on unless it is necessary.  
Note that, if you turn off the unit's power while the backlight continuously lights and then turn on the unit, the backlight continuously lights.

You can adjust the display contrast by pressing this key while holding down the [SHIFT] key. See "Adjusting the display contrast" on page 30 for details.

13) **[FILE NEXT] / [LOC ] key**

When more than one audio file exists on the card, pressing this key switches the current file to the next entry in the list.

If any cue points (CUE 01 through 99) are stored in the current file, pressing this key while holding down the [SHIFT] key skips forwards to the next cue point.

14) **[SHIFT] key**

Some key has a secondary (SHIFTed) function which is labeled in a rectangular box below the key. To execute the SHIFTed function of such a key, press the key while holding down the [SHIFT] key.

15) **[MENU/ENTER] /  key**

Pressing this key enters the MENU mode. In the MENU mode, pressing this key completes setting or executes the selected operation.

Pressing this key while holding down the [SHIFT] key enters the quick setup mode which allows you to work on some menus on the Home screen (see page 55).

16) **[+] /  key**

While making editing in the MENU mode, this key functions as the UP key.

Pressing this key while holding down the [SHIFT] key switches on or off the panel lock.

While the panel lock is active, only the following keys are effective.

Effective keys: [REC] key, [STANDBY] key, [+] /  key

17) **Internal microphones (L and R channels)**

To make recording using the internal microphones, Select "Source Sel" on the Setup menu in the MENU mode to the internal microphones (see pages 57 and 93). You can select between high and low sensitivities.

18) **[-] / [MARK] /  key**

By pressing this key while recording, playing back or stopped, the current position is stored as a cue point "on the fly" (you cannot store a cue point on an MP3 file).

You can store up to 99 cue points (01 through 99). By default, cue points are labeled as "Cue01", "Cue02", etc. according to the order you store points.

By pressing this key while holding down the [SHIFT] key while playback (or stopped), the cue point before the current position is deleted.

19) **[PLAY] key**

Starts playback of the current file.

20) **[STOP/CANCEL] key**

Stops the transport.

When the unit is in the MENU mode, pressing this key directly exits the MENU mode.

Pressing the [F FWD] or [REWIND] key while holding down the [STOP] key moves the transport as follows.

[STOP] + [REWIND]	Moves the transport to the beginning (ABS 0) of the file. <i>&lt;Note&gt;: When there is more than one audio file, the unit locates the beginning of the first recorded audio file.</i>
[STOP] + [F FWD]	Moves the transport to the record end position (REC END) of the file. <i>&lt;Note&gt;: When there is more than one audio file, the unit locates the last recording position of the most recently recorded audio file.</i>



21) **[F FWD] key**

While stopped, pressing this key fast-forwards the transport.

During playback, pressing this key cues the transport in the forward direction at up to double speed.

By pressing this key while holding down the [STOP/CANCEL] key locates the record end point (REC END) of the file.

22) **[REWIND] key**

While stopped, pressing this key rewinds the transport.

During playback, pressing this key cues the transport in the reverse direction at up to normal speed.

By pressing this key while holding down the [STOP/CANCEL] key locates the beginning (ABS 0) of the file.

**<Note>**: With a file recorded in the MP3 mode, you cannot operate cueing playback.

## Left side panel

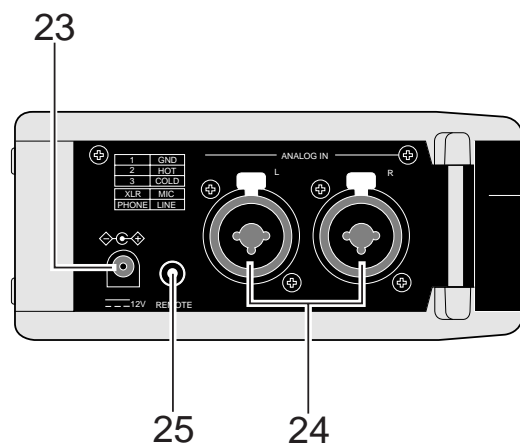

23) **DC IN jack**

This jack is used to connect the supplied AC adaptor. See page 20.

24) **[ANALOG IN (L, R)] connectors**

These connectors are "Combo" type (both 1/4" and XLR) and can connect an external microphone via the XLR connector or an external line level source via the 1/4" connector (though you cannot connect both simultaneously).

You can adjust the L and R input levels independently using the [TRIM] controls.

**<Note>**: When you use the [ANALOG IN] connectors, select the source to "Input" using the quick setup function or using the "Source Sel" item on the Setup menu in the MENU mode (see pages 55 and 94). If the source is set to the internal microphones, the [ANALOG IN] connectors are disabled.

25) **[REMOTE] jack (stereo mini jack)**

This jack is used for connecting the remote controller which is supplied with the unit (see page 52).

Using the remote controller, you can enter record standby mode, start recording, or mark cue points.

**Right side panel**

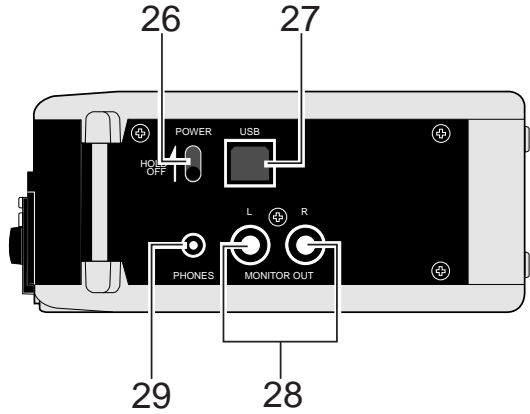

- 26) **[POWER] switch**  
Turns on or off the unit's power. To turn off the power, hold the switch up for two seconds.
  
- 27) **[USB] port (PC ONLY)**  
This port is exclusively used for connecting a PC. By connecting a PC to this port, you can transfer audio files between the unit and PC.  
For details about the file transfer, see pages 52 and 72.
  
- 28) **[MONITOR OUT] (L, R) connectors (RCA)**  
These connectors output -10dBV analog audio signals.
  
- 29) **[PHONES] jack (stereo mini jack)**  
Connects headphones for monitoring.  
Inserting a plug automatically disables the internal monitor speaker.

**Back panel**

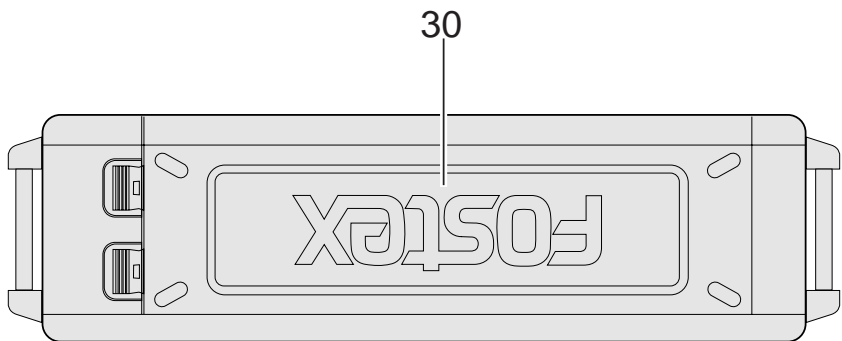

- 30) **Battery compartment**  
This compartment houses batteries for operating the unit. See "About power supply" on page 20 for details.

## Bottom panel

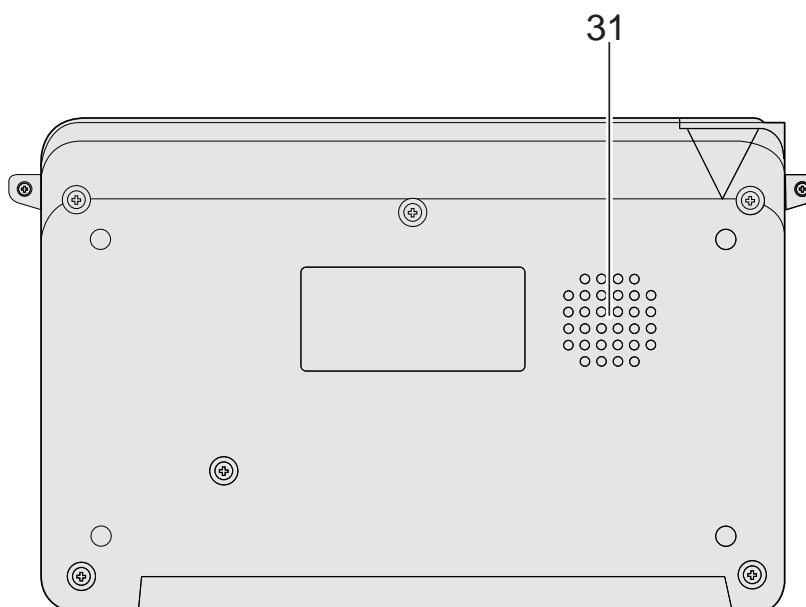

### 31) Internal monitor speaker

This speaker is used for monitoring.

You can control the monitor level using the [MONITOR] control.

**<Note>**: When a headphones plug is inserted to the [PHONES] jack or during input monitor mode and recording, this monitor speaker is muted.

**<Note>**: You can disable the internal speaker using the "Speaker Out" item on the "Setup" menu in the MENU mode (by default, it is not disabled). See page 97 for details.

## Details about screens

The FR-2LE features 132 x 64 dot LCD display for showing record/playback levels, file information, card remaining time, battery information, setting information, realtime clock information, etc.

### Home screen

After the unit is turned on and starts up, the "Home screen" appears on the display. During recording or playback, the Home screen is normally shown.

**•When no memory card is set**

When no memory card is set in the card slot, turning on the unit brings up the Home screen as shown below after the unit starts up. "<<No Disk>>" is shown on the screen.



**•When a formatted blank memory card is set**

When you set a FAT32-formatted blank memory card to the slot and turn on the unit (or when you turn on the unit and set such a card to the slot), the Home screen as shown below appears after the unit starts up.

You can see "<<No Audio Files>>", as well as the remaining (recordable) space of the current card. (the remaining space is shown in time or Mbytes according to the setting of the "Remain Display" menu item on the "Setup" menu in the MENU item. By default, it is shown in time.) See page 104 for details.

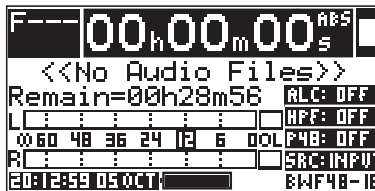

**•When a recorded memory card is set**

When you set a memory card to which recording has been made by the FR-2LE to the slot and turn on the unit (or when you turn on the unit and set such a card in the slot), the Home screen as shown below appears after the unit starts up.

The recorder is stopped at the beginning of the current audio file ("File 001").

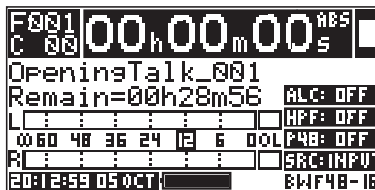

You can turn on or off the backlight of the LCD display, as well as adjust the contrast, allowing you to see the display comfortably in any environment. See "Adjusting the display contrast" on page 30 for details.

On the Home screen, you can see the following information.

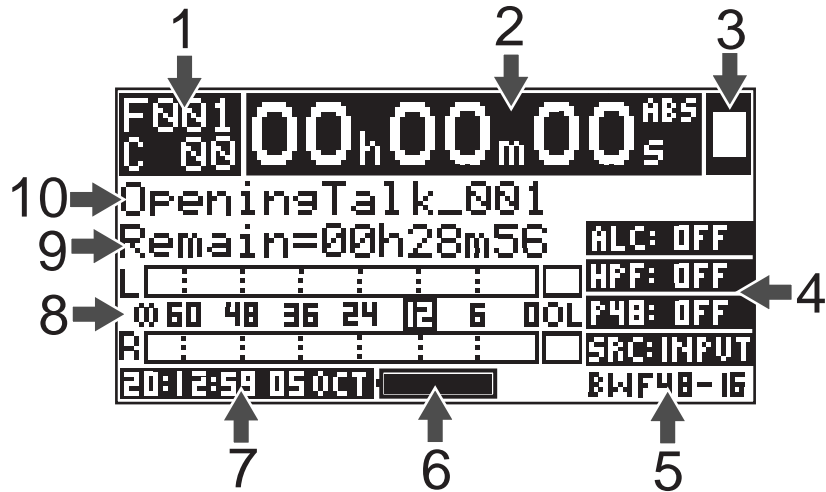

1	File number / Cue information	This area shows the current file number and the cue number information.
2	Time counter	This counter shows the current position of the file in ABS time, PRG or 24H (Time Stamp). The time mode can be set by the "Time Display" menu item on the "Setup" menu in the MENU mode (the default time mode is "ABS").
3	Transport status	This area shows transport status using symbols. For example, you can see "■" while stopped, or "●" during recording.
4	Quick setup mode settings	The current settings of some items of the "Setup" menu are shown. By pressing the [MENU/ENTER] key while holding down the [SHIFT] key, you can set these items directly from the Home screen without the need of entering the MENU mode.
5	Recording format	Recording format which is set when formatting the card is shown.
6	Battery (BATT) indicator	This indicator shows the battery power condition when the unit is running on batteries. When you need to replace batteries, the battery indicator flashes.
7	Realtime clock indicator	This indicator shows the internal realtime clock information in "day, month, hour and minute". You can adjust the time and date via the "Adjust Real Time Clock" item on the "Setup" menu in the MENU mode.
8	Level meters	These meter show recording/playback levels of L and R channels. The reference level corresponds to -12 dB.
9	Remaining time (or space)	This area shows the remaining (recordable) space of the memory card in Mbytes or time. The remaining display mode (Mbytes or time) can be set via the "Remain Display" item on the "Setup" menu in the MENU mode (the default is "Time").
10	File name	This area shows the current audio file name. Up to 16 characters can be displayed. The file name is automatically given when recording is made according to the File Name Mode and Default File Name settings. You can also edit the name after recording via the "Rename" item on the "File" menu in the MENU mode.

## MENU mode screens

By pressing the [MENU/ENTER] key while stopped, the FR-2LE enters the MENU mode and the display changes to show the MENU mode screen. In the MENU mode, the File menu, Disk menu, Setup menu and USB Mode menu are available. Each menu has various menu items, from which you can make desired settings according to your system or purpose.

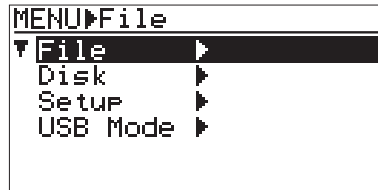





"▶" at the right of a menu title shows that the menu has more than one pages. See "Chapter 7: Menu mode" starting from page 77 for details about the MENU mode.

## Warning message screen

In a case that the operation is inappropriate, entered data is illegal, or an error happens, a warning message screen may appear on the display. The following shows available warning message screen with comments including remedies. If you encounter any warning message, immediately cope with the trouble.

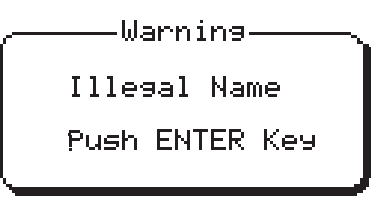
<p>Warning Battery Empty</p>	<p>This message appears when batteries for operating the FR-2LE are exhausted. The FR-2LE automatically shuts down after showing this warning message. Replace batteries with new (or fully charged) ones.</p>
<p>Warning RTC Battery Empty Push ENTER Key</p>	<p>This message appears when the battery for operating the internal realtime clock is exhausted. This message appears when turning on the power. Ask your local Fostex dealer or sales office for replacing the battery.</p>
<p>Warning Memory Error Push ENTER Key</p>	<p>This message appears when the memory card inserted to the slot has a problem. Replace the card with another one.</p>
<p>Warning Disk Full Push ENTER Key</p>	<p>This message appears when the current memory card does not have enough remaining space for recording. Replace the card with another one which has enough remaining space.</p>

 <p>File Over!</p>	<p>This message appears when you cannot create an audio file to the current memory card any more. To create a new audio file, delete an unnecessary file or replace the card to another one.</p>
 <p>Rename error!</p>	<p>When you are going to store an audio file name, this message appears if a file with the same name already exists in the card. Change the audio file name to be stored.</p>
 <p>Warning Illegal Name Push ENTER Key</p>	<p>When you are going to store an audio file name, this message appears if the name is illegal. Enter a legal name and store it.</p>
 <p>Warning No Memory Cards Push ENTER Key</p>	<p>When you are going to make setting of any menu item (except for menu items on the Setup menu) in the MENU mode, this message appears if no memory cards are inserted to the slots. Insert a memory card and make setting.</p>





# Chapter 4: Basic connections

This chapter describes basic connections of the FR-2LE.

## <Table of contents>

<b>Audio connections .....</b>	<b>50</b>
Connecting to an external microphone .....	50
Connecting to the line outputs of an external audio device .....	50
Connecting to a monitor system .....	51
Connecting to headphones .....	51
<b>Other connections .....</b>	<b>52</b>
Connecting to a PC .....	52
Connecting to the remote controller .....	52

## Audio connections

The [ANALOG IN] section of the FR-2LE provides combo type balanced connectors which combine XLR-3-31 (pin 2=hot) and TS phone jacks. These connectors accept a wide range of inputs from microphone level to line level.

When you connect external microphones or line outputs of an external audio device as recording sources, set the "Source Sel" menu item on the "Setup" menu in the MENU mode to "Input". (When you make recording using the internal microphones, set this item to "I MIC L" or "I MIC R".) See pages 57 and 94 for details.

### Connecting to an external microphone

---

You can connect an external microphone to either of the [ANALOG IN (L, R)] connectors using an XLR connector. The XLR connection accepts an analog audio signal between -50dBu and -10dBu nominal level. You can adjust the L and R input levels independently using the [TRIM] controls.

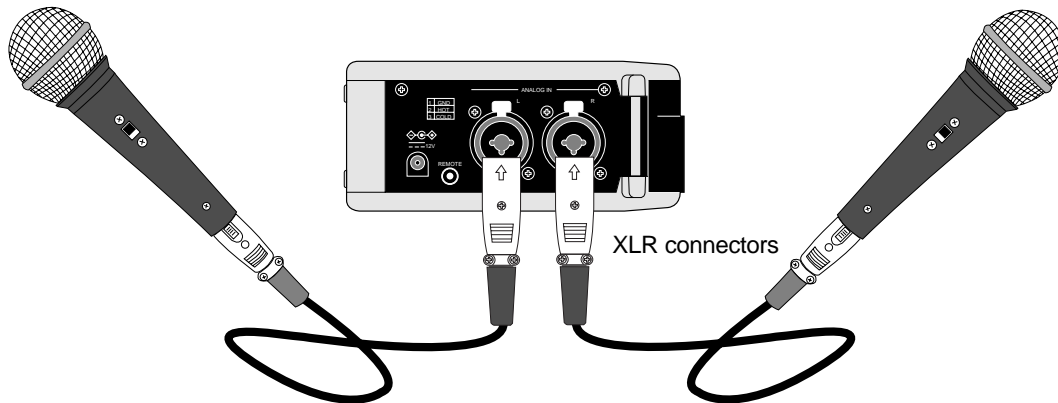

The FR-2LE provides the HPF (high-pass filter) and limiter functions which are useful for recording using external microphones. It also provides +48V phantom power capability for condenser microphones. See pages 55 and 92 for details about HPF and limiter on/off settings. See page 95 for details about phantom power on/off setting.

### Connecting to the line outputs of an external device

---

You can connect the line outputs of an external audio device to the [ANALOG IN (L, R)] connectors using 1/4" TS phone plugs.

The phone plug connection accepts a -10dBV analog audio signal.

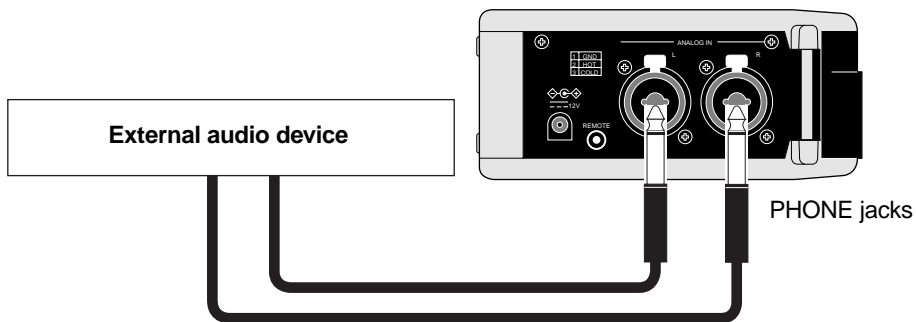

## Connecting to a monitor system

Use the [MONITOR OUT] jacks (RCA pin jacks) on the right side panel to connect to external monitoring equipment. You can adjust the monitor level using the [MONITOR] control.

**<Note>**: When a headphone plug is plugged into the [PHONES] jack, no audio signal is output from the [MONITOR OUT] jacks and the internal monitor speaker.

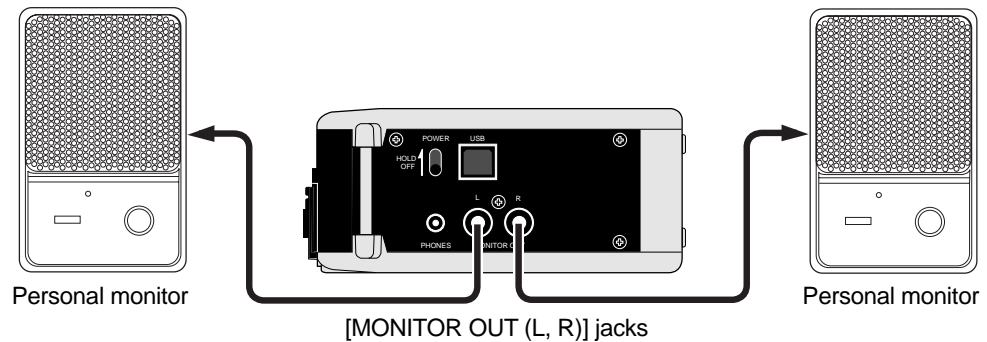

You can select whether the monitor signals are output in mono or stereo using the "Monitor Mode" menu item on the "Setup" menu in the MENU mode.

The error tone is also output from the [MONITOR OUT] jacks. See page 96 for the details about the "Monitor Mode" setting and page 107 about the error tone setting.

## Connecting to headphones

Connect a pair of headphones for monitoring to the [PHONES] jack (mini jack) on the right side panel. You can adjust the monitor level using the [MONITOR] control.

**<Notes>**

- When a headphone plug is plugged into the [PHONES] jack, no audio signal is output from the [MONITOR OUT] jacks and the internal monitor speaker.
- To prevent possible hearing damage, do not listen at high volume levels for long periods.

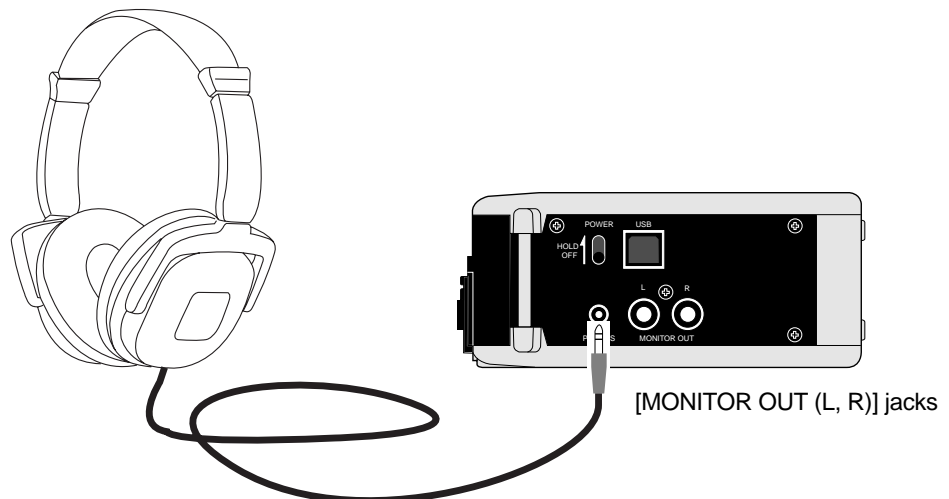

## Other Connections

### Connecting to a PC

The FR-2LE provides the [USB] connector which is used for directly connecting to a PC. By connecting the FR-2LE to a PC via this connector, you can control the current memory card of the FR-2LE from the PC and transfer audio files to the PC. See "Chapter 6: Exporting audio file to a PC" starting from page 69 for details about audio file export/import.

**<Notes>**

- To use the FR-2LE with a personal computer, make the USB mode active using the "USB Device Mode" item on the "Setup" menu in the MENU mode. See page 71 for details.
- A USB cable is not supplied with the FR-2LE. Purchase a commercially available appropriate USB cable which conforms to the USB port standard.

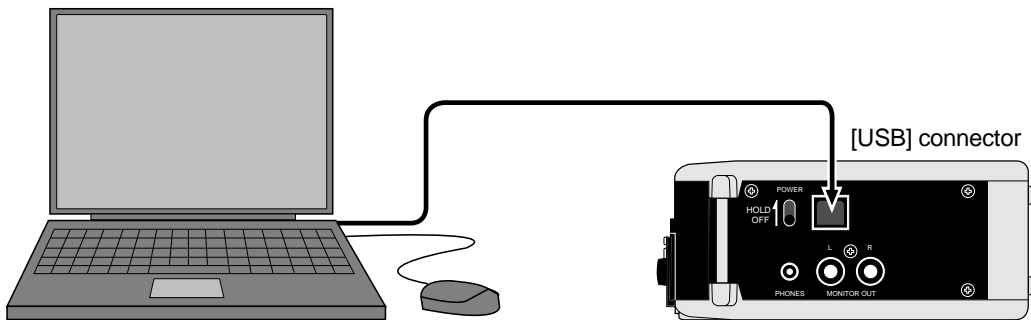

### Connecting to the remote controller

The FR-2LE is equipped with the [REMOTE] jack for connecting the remote controller which is supplied with the unit. Using the remote controller, you can enter record standby mode, start recording, or mark cue points.

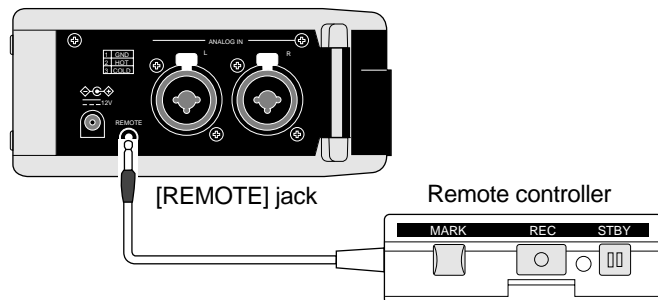

**<Tip>**

The supplied fixing belt for the remote controller can be used as shown in the figure on the right. You can fix it to a shoulder belt, an external microphone, etc.

Also you can fix a strap to the hole shown by an arrow in the figure on the right.

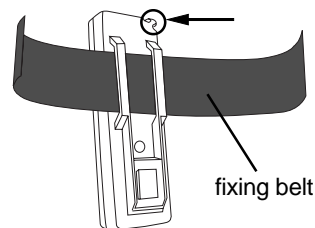

# Chapter 5: Recording/playback

This chapter describes basic analog and digital audio recording/playback, as well as cue point setting and the skip/locate function.

## <Table of contents>

<b>About recording system .....</b>	<b>54</b>
<b>Setup before you start recording .....</b>	<b>55</b>
Setup in quick setup mode .....	55
How to make setting in the quick setup mode .....	56
ALC (Auto Level Control) setting (if needed) .....	57
HPF (High Pass Filter) on/off (if needed) .....	57
Phantom power on/off setting (if needed) .....	57
Recording source selection (must setting) .....	57
Using the menu mode .....	58
Default file name setting (if needed) .....	58
Pre record function on/off setting (if needed) .....	58
Maximum file size setting (if needed) .....	59
Monitor output mode setting (if needed) .....	59
Error tone output setting (if needed) .....	59
Time display mode (if needed) .....	59
<b>Recording audio .....</b>	<b>60</b>
Adjusting the input gain .....	60
Adjusting the recording level .....	60
Adjusting the external source (microphone or line input) level .....	60
Adjusting the internal microphone level .....	61
Starting recording .....	62
<b>Setting cue points .....</b>	<b>63</b>
Setting a cue point on-the-fly .....	63
Viewing cue point information .....	64
Deleting a cue point in realtime .....	64
<b>Playback .....</b>	<b>65</b>
Normal audio playback .....	65
Cueing playback .....	66
<b>Skip/Locate functions .....</b>	<b>66</b>
Skipping by file .....	66
Skipping by cue point .....	66
Locating to the beginning (ABS 0) of a file .....	67
Locating to the end (REC END) of a file .....	67

## About recording system

The FR-2LE uses the FAT32 (File Allocation Table 32) file system and supports the most common BWF (Broadcast Wave File) and MP3 (MPEG-1 Audio Layer3) file formats. You can make recording in stereo (L/R). The FR-2LE uses the "1 take - 1 file" system.

With this system, Each time you make recording, a BWF or MP3 file is automatically created and a pair of L and R audio signals is stored to it. A BWF file created in the "BWFF" folder, while an MP3 is created in the "MP3F" folder (see the figure below).

Note that you cannot make additional recording or overwriting to an existing file.

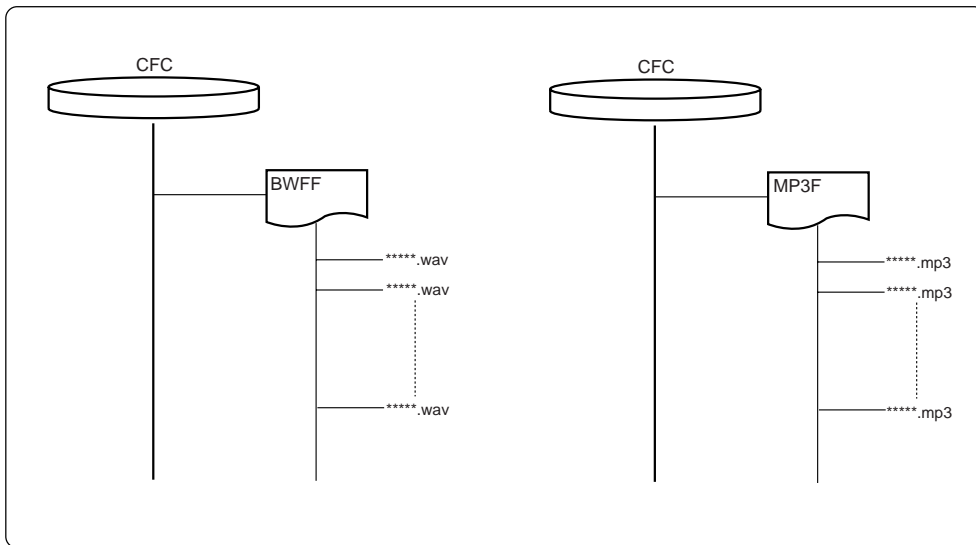

By connecting the FR-2LE to your personal computer, you can transfer an audio file recorded by the FR-2LE to the personal computer, and vice versa. Therefore, you can copy an audio file recorded by the FR-2LE to a personal computer's hard disk drive or export it to a computer application such as Digidesign Pro Tools.

The table below shows the approximate recording time for each recording format on a 1GB card.

Note that actual recording time may be slightly different depending on card manufacturers.

Recording format	Maximum recording time
44.1kHz / 16bit, BWF file mode	Approx. 96 minutes
44.1kHz / 24bit, BWF file mode	Approx. 64 minutes
48kHz / 16bit, BWF file mode	Approx. 90 minutes
48kHz / 24bit, BWF file mode	Approx. 60 minutes
88.2kHz / 24bit, BWF file mode	Approx. 32 minutes
96kHz / 24bit, BWF file mode	Approx. 30 minutes
PM3 / 192kbps, Compressed file mode	Approx. 670 minutes

## Setup before you start recording

Before you start recording, set up the following items.

You can set them up using the "Setup" menu in the MENU mode, however, you can also set up the first four items below using the quick setup mode.

	Setup item	Available options	Default
1	Auto level control/limiter	OFF, ON, LIMIT	OFF
2	High-pass filter	OFF, ON	OFF
3	Phantom power	OFF, ON	OFF
4	Recording source	INPUT, I. MIC L, I. MIC H	INPUT
5	File name mode	Take, Date, Reel	Date
6	Pre Record function	OFF, ON	OFF
7	Max. file size	2G, 4G	2G
8	Monitor output mode	L/R (stereo), MONO	L/R
9	Error tone output	OFF, ON	OFF
10	Internal speaker output	OFF, ON	ON
11	Time display mode	ABS, PGM, 24H	ABS

## Setup in quick setup mode

Before starting audio recording, you can make necessary settings in the quick setup mode. For details about the actual procedure in the quick setup mode, see the next page.

### Quick setup mode:

In the quick setup mode, you can quickly set up the first four items in the table above from the Home screen, without the need of entering the MENU mode.

At the right of the Home screen, there are four icons for the quick setup items. Using these icons, you can make settings by following the procedure shown on the next page.

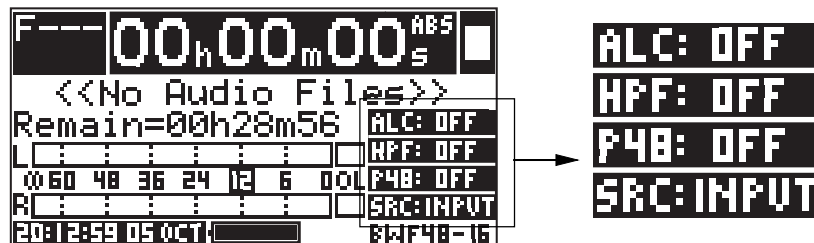

**<Note>** The setting you make in the quick setup mode is immediately reflected to the setting of the appropriate menu item on the "Setup" menu in the MENU mode, and vice versa.

## How to make setting in the quick setup mode

You can make setting in the quick setup mode by the procedure below.

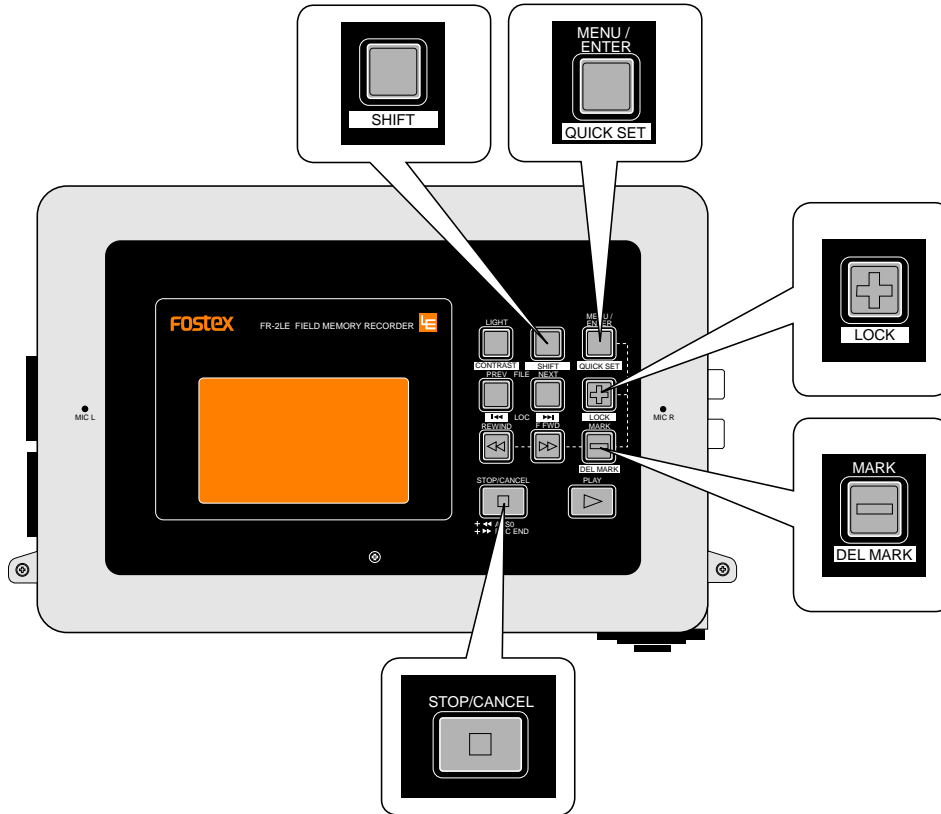

- 1) **When the recorder is stopped, press the [MENU/ENTER] key while holding down the [SHIFT] key.**  
 The unit enters the quick setup mode and "ALC:" of "ALC: OFF" starts flashing on the Home screen.  
 This shows that the setting item is "ALC (Auto Level Control)". In this condition, pressing the [+] or [-] key switches the flashing item in the following order.

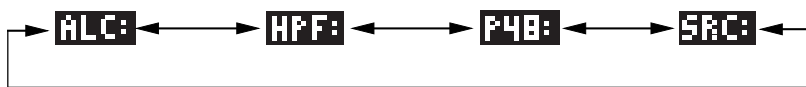

- 2) **Use the [+] or [-] key to select the desired setting item and press the [MENU/ENTER] key.**  
 The current setting of the selected item starts flashing and you can now select the option.  
 For example, if you select "ALC:" and press the [MENU/ENTER] key, "OFF" (the default) starts flashing.
- 3) **Use the [+] or [-] key to select the desired option and press the [MENU/ENTER] key.**  
 The selected option is set, and "ALC:" now starts flashing.  
 To make setting of another item, repeat steps 2) and 3) above.
- 4) **After you complete setting, press the [STOP/CANCEL] key to exit the quick setup mode.**

See the following pages for details about each item.



## ALC (Auto Level Control) setting (if needed)

The "ALC" item in the quick setup mode allows you to enable the auto level control function or the limiter. When you record a microphone signal, use of the limiter function will help prevent clipping audio and keep the appropriate recording signal level. The setting is effective to both the L and R channels.

Off (default)	Both the ALC and the limiter functions are disabled.
On	The ALC (Auto Level Control) function is enabled.
LIMIT	The limiter function is enabled.

**<Tip>**: You can also make ALC setting using the "ALC" item on the "Setup" menu in the MENU mode (see page 91).

## HPF (High Pass Filter) on/off setting (if needed)

The "HPF" item in the quick setup mode allows you to select on or off for the high-pass filter (the default is "OFF").

The filter of the unit is a high-pass type with a cutoff frequency of 100 Hz and a slope of -12 dB/oct. This filter is effective to prevent the unwanted wind noise or low-frequency noise when you make outdoor recording using an external microphone.

The filter is effective to both the L and R channels.

**<Tip>**: You can also make HPF on/off setting using the "HPF" item on the "Setup" menu in the MENU mode (see page 92).

## Phantom power on/off setting (if needed)

The "P48" item in the quick setup mode allows you to select on or off for the phantom power (the default is "Off").

If you make recording using a condenser microphone which requires the phantom power, set this item to "ON". The phantom power is supplied to the [ANALOG IN] XLR connectors of the L and R channels.

**<Tip>**: You can also make phantom power on/off setting using the "Phantom" item on the "Setup" menu in the MENU mode (see page 95).

## Recording source selection (must)

The "SRC" item in the quick setup mode allows you to select the recording source between an external source fed to the [ANALOG IN] connector or the internal microphones. When you use the internal microphones, you can select high or low sensitivity according to the sound source level or the distance between the sound source and the unit.

INPUT (default)	An external source fed to the [ANALOG IN] connector
I. MIC L	The internal microphones at low sensitivity (16 dB)
I. MIC H	The internal microphones at high sensitivity (32 dB)

**<Tip>**: You can also make recording source selection using the "Source sel" item on the "Setup" menu in the MENU mode (see page 94).

**<Notes>**: When you make recording using the internal microphones, the [MIC TRIM] and the recording level controls are not effective.

## Using the menu mode

You can make setting of the following preference items other than the four items in the quick setup mode using the "Setup" menu in the MENU mode.

### Default file name setting (if needed)

---

When you starts recording, an audio file is newly created on the memory card and its file name is automatically given. The file name can be set using the "File Name Mode" and "Def. File Name" items on the "Setup" menu in the MENU mode.

By default, the "File Name Mode" item is set to "Date" and the time information when you start recording is given as the default file name, as shown in the example below.

- Example of BWF recording: B15h 20m 35s 20jan 2007.wav
- Example of MP3 recording: B15h 20m 35s 20jan 2007.mp3

By changing the "File Name Mode" item to "Take" or "Reel", the file name is given as below.

#### When "Take" is selected:

- Example of BWF recording: Scene Name + Take Number.wav
- Example of MP3 recording: Scene Name + Take Number.mp3

The Scene name and take number are specified by the "Def. File Name" item on the "Setup" menu.

#### When "Reel" is selected:

- Example of BWF recording: Reel Number + File Number.wav
- Example of MP3 recording: Reel Number + File Number.mp3

**<Tip>**: You can change file names of an audio file later by using the "Rename" item on the "File" menu in the MENU mode (see page 81 for details).

### Pre record function on/off setting (if needed)

---

Pre record function allows recording to start with two-second audio data captured in the buffer. This prevents missing the start of a take.

If you operates the [REC] key to start recording while the pre record function is enabled (it is disabled by default), recording starts with the 2 seconds of audio data stored in the buffer. When you attempt to stop recording, the unit stops recording after executing "post recording" which records audio data currently stored in the buffer.

To enable the pre record function, set the "Pre Rec" item on the "Setup" menu in the MENU mode to "ON" (see page 102).

## Maximum file size setting (if needed)

---

The maximum size of an audio file is set to "2 GB" by default. We recommend you to set the maximum file size depending on the file size your personal computer can import.

The maximum file size can be selected between "2 GB" and "4 GB" via the "Max File Size" item on the "Setup" menu in the MENU mode (see page 105).

**<Note>**: During recording, the recorder automatically quits recording and stops if the file size reaches the maximum file size. Note that if you use a memory card whose size is less than the maximum file size, the recorder stops recording at the point when there is no more recording space left.

## Monitor output mode setting (if needed)

---

Via the [PHONES] or [MONITOR OUT] jacks, you can monitor recording or playback audio signals. During recording, the internal speaker is disabled by default. You can select whether you monitor the signals in mono or stereo using the "Monitor Mode" item on the "Setup" menu in the MENU mode. By default, the "Monitor Mode" item is set to "Stereo" (see page 96).

**<Note>**: While the unit is battery-powered, do not unnecessarily raise the monitor level for reducing battery power consumption.

## Error tone output setting (if needed)

---

The error tone can be output to warn you when;

- the remaining time of the memory card gets shorter than the specified time.
- the battery voltage lowers the certain level.

You can enable or disable the error tone via the "Error Tone" item on the "Setup" menu in the MENU mode. The default is "Off" (disabled), so if you want to enable it, change the setting to "On" (see page 107 for details).

## Time display mode setting (if needed)

---

By default, the time display mode is "ABS".

In this mode, the time counter starts from the beginning of the first audio file which is set to zero (ABS 0) and indicates the elapsed time from "ABS 0". Time is counted continuously throughout all audio files.

You can select the time display mode from among "ABS", "PRG" and "24H" (see page 103 for details).

## Recording audio

In the following description, it is assumed that the necessary settings for recording are made using the quick setup mode or MENU mode and no audio is recorded to the memory card ("**<<No Audio Files>>**" is shown on the screen).

### Adjusting the input gain

When you make recording using an external microphone connected to the [ANALOG IN] XLR connector, adjust the input gain using the appropriate [MIC TRIM] control. Note that the [MIC TRIM] controls are not effective for line input sources (connected to the [ANALOG IN] phone connectors) or the internal microphones.

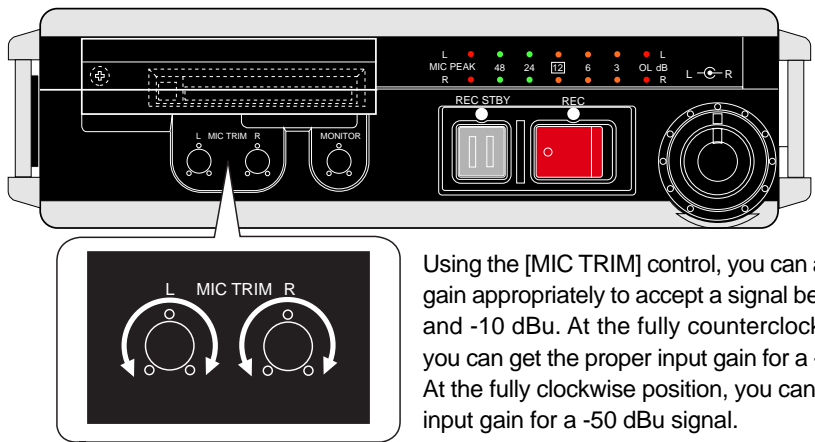

Using the [MIC TRIM] control, you can adjust the input gain appropriately to accept a signal between -50 dBu and -10 dBu. At the fully counterclockwise position, you can get the proper input gain for a -10 dBu signal. At the fully clockwise position, you can get the proper input gain for a -50 dBu signal.

### Adjusting the recording level

You must adjust the recording level appropriately according to the recording source.

#### When recording an external source (microphone or line input)

Press the [REC STBY] key to enter the input monitor mode, and adjust the recording level using the recording level controls while monitoring the level meters on the front panel or on the screen.

Especially when you record a microphone signal, adjust the [MIC TRIM] control appropriately so that the [MIC PEAK] indicator on the level meter does not light.

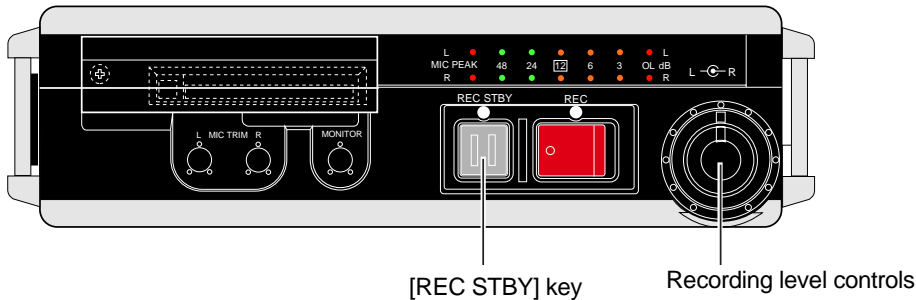

## When recording with the internal microphones

Press the [REC STBY] key to enter the input monitor mode, and adjust the direction of the internal microphones as well as the distance between the sound source and the internal microphones to get the appropriate recording level. You can check the recording level via the level meters on the front panel or on the screen. (Note that the recording level controls are not effective when using the internal microphones.)



**<Notes>**: Adjust the recording level appropriately so that the corresponding LED level meter on the front panel or on the screen does not exceed "0 dB".

To get the maximum signal-to-noise performance, set the recording level appropriately so that the meter indication does not exceed "0 dB" but goes up near to the "0 dB" at the loudest part of the input signal. When the "OL" indicator on the meter is frequently lit, the sound may be distorted.

The "MIC PEAK" indicator on the LED level meter is lit when the microphone amplifier receives the overload signal. When recording a signal from an external microphone, adjust the [MIC TRIM] control appropriately so that the "MIC PEAK" indicator does not light. The reference level is set to the "-12 dBFS" relative to digital full-scale.

"12" of the onscreen meter is labeled in inverse video, showing that it is the reference position.

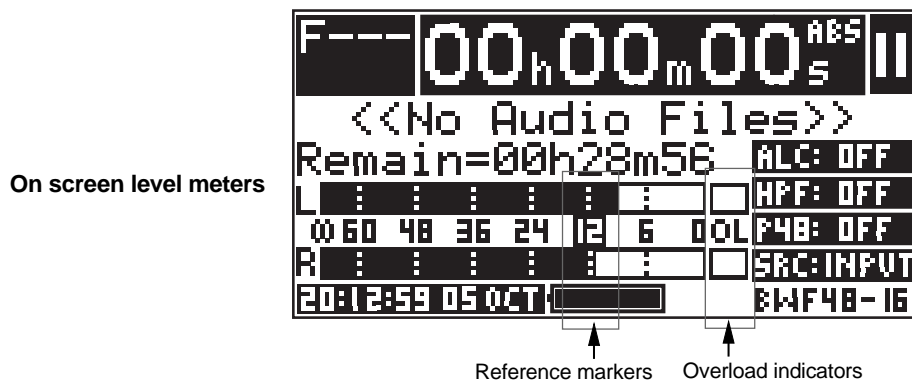
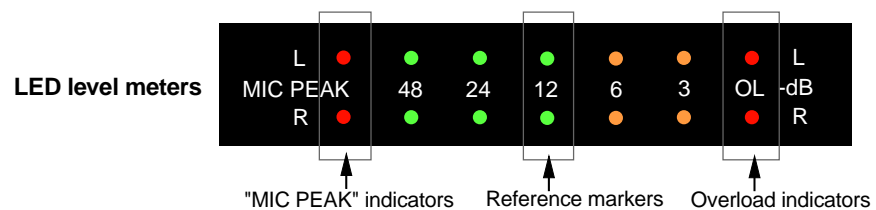

## Starting recording

After adjusting the recording level appropriately, you are now ready to start recording. Each time the unit makes recording, it creates an audio file on the memory card.

**Note that the unit cannot make additional recording to an existing audio file.**

**<Tip>**: You can lock the operation panel by pressing the [ + ] / [ LOCK ] key while holding down the [ SHIFT ] key. When you lock the operation panel, the "key" icon is shown on the display and all keys on the operation panel except the [ REC ] and [ REC STBY ] keys are disabled for preventing accidental operation.

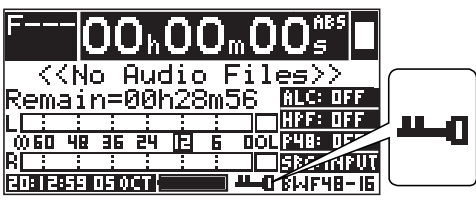

**<Tip>**: The unit automatically closes the file every one minute. Therefore, if unexpected power failure or accident happens while operating the unit using the AC adaptor, you do not lose the data recorded before the trouble happens.

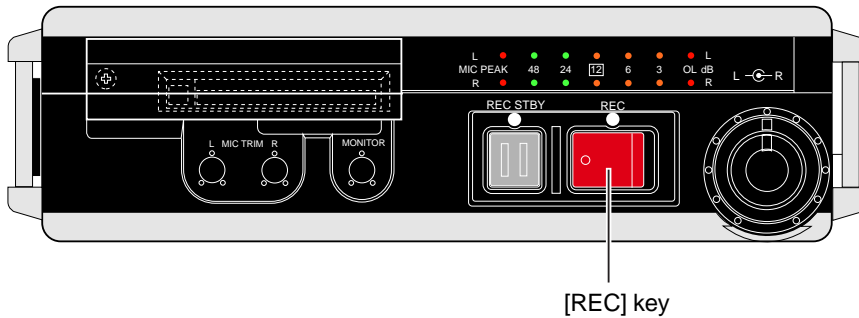

- 1) **While the unit is in the input monitor mode, slide the [REC] key to the right.**  
 The unit creates a new audio file on the memory card and starts recording.  
 If you set "Pre Rec" to "On", recording starts with 2 seconds of audio data stored in the buffer (see page 58).  
 The file name for the new audio file is given according to the "File Name Mode" setting (see page 58).

**<Note>**: If you start recording by sliding the [REC] key to the right while the unit is not in the input monitor mode, it takes approximately one seconds until the unit starts recording. To prevent missing the beginning of the material to be recorded, it is recommended to make the input monitor mode active before you start recording.

- 2) **To stop recording, press the [REC STBY] key (or the [STOP/CANCEL] key).**  
 If you stop recording by pressing the [REC STBY] key, the input monitor mode is maintained. If you stop recording by pressing the [STOP/CANCEL] key, the input monitor mode is released.

**<Note>**: Recorded audio files are automatically set to the ADL (Audio Decision List) and can be played back continuously in the order of creation. All files in the ADL are displayed on the screen when you select the File menu from the main menu of the MENU mode. You can delete a desired audio file from the ADL, as well as restore the deleted file to the desired position in the ADL. See pages 83 and 84 for details.

**<Tip>**: By connecting the unit to your personal computer, you can import a recorded audio file (BWF or MP3) to the personal computer (see page 69).

## Setting cue points

The FR-2LE can store cue points, which can be used as markers. You can manually set and store a cue point at the desired position during recording (or while stopped).

### Setting a cue point on-the-fly

You can set a "cue point" at the position you press the [MARK] / [DEL MARK] key during recording/playback or while stopped. Up to 99 cue points can be set for each audio file.

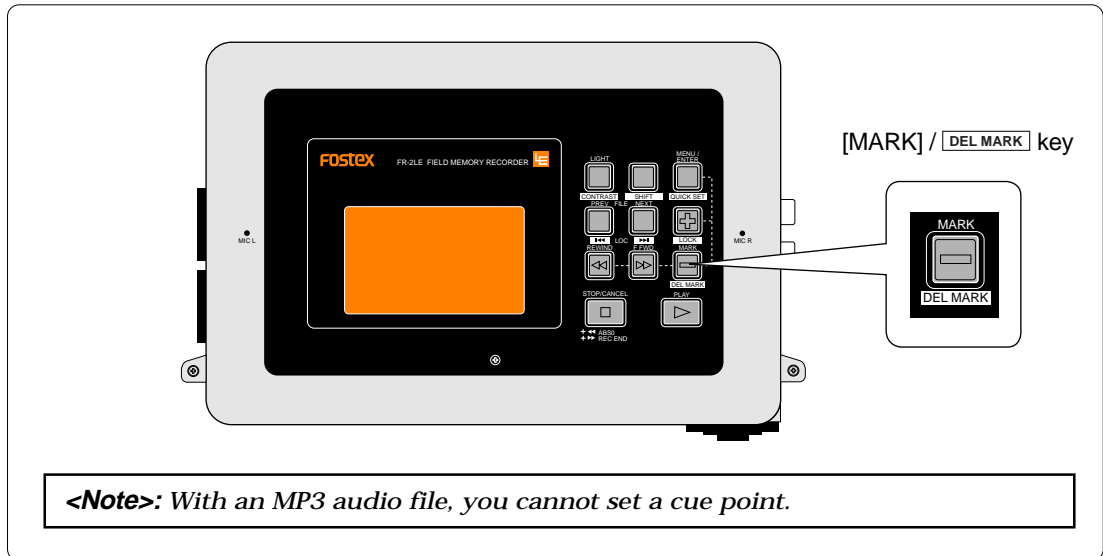

If you set a cue point repeatedly, the given cue number is counted up. You can use the stored cue points for the skip functions. You can delete an unnecessary cue point.

See page 64 for details about how to delete a cue point. See "Skip/locate function" on page 66 for details about the skip function using a cue point.

### Viewing cue point information

On the Home screen, you can see a cue point number at the position pointed by the arrow below.

In the screen example below, the current recorder position is the beginning of the file ("ABS 0") and the nearest cue point is cue 01.

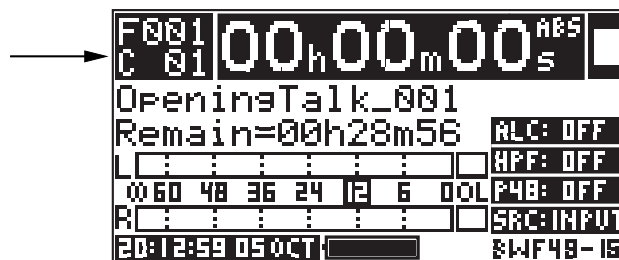

**<Note>:** The nearest cue point in the forward direction from the current position is shown on the Home screen.

## Deleting a cue point in real-time

During playback (or while stopped), pressing the [MARK] / [DEL MARK] key while holding down the [SHIFT] key deletes the cue point before the current recorder position in realtime. For example, if the cue point information on the Home screen shows "C 03" as below, operating as above deletes cue 03.

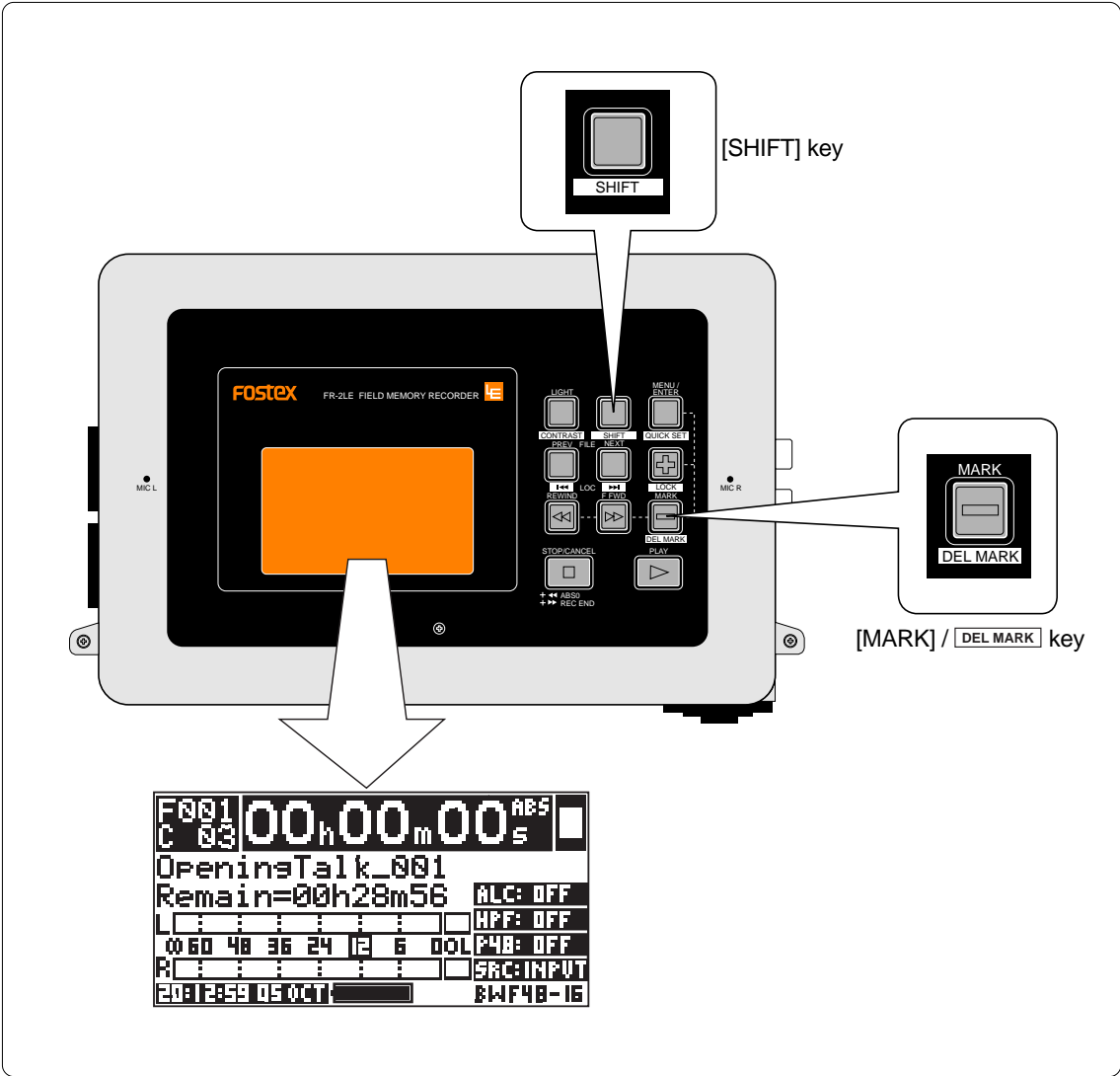



## Playback

In the following description, it is assumed that more than one audio file is recorded to the card and the recorder is stopped at the beginning of the first created audio file.

### Normal audio playback

- 1) **Press the [PLAY] key to start playback.**

The [PLAY] indicator is lit.

**<Tip>**: Recorded audio files are automatically added to the ADL (Audio Decision List) in the order of creation, and can be played back continuously in the order of the ADL. To select an audio file from which you want to start playback, see "How to select an audio file" described below.

- 2) **You can monitor the playback sound via headphones (or the internal speaker).**

Adjust the monitor level using the [MONITOR] control.

- 3) **To stop playback, press the [STOP/CANCEL] key.**

**<Tip>**: When finishing playback of all files in the ADL, the unit automatically stops playback.

#### <How to select an audio file>

To select an audio file from which playback starts, carry out either of the following two methods.

#### <Using the [PREV] / [◀◀] and [NEXT] / [▶▶] keys>

While the recorder is stopped, pressing the [PREV] / [◀◀] or [NEXT] / [▶▶] key selects the previous or next audio file (the recorder skips to the beginning of the selected file).

#### <Using the MENU mode>

- (1) **Press the [MENU/ENTER] key while the recorder is stopped enters the MENU mode.**

```
MENU▶File
▼ File ▶
Disk ▶
Setup ▶
USB Mode ▶
```

- (2) **While "File>" is highlighted, press the [MENU/ENTER] key.**  
The display now shows the list of audio files on the memory card.

```
MENU▶File ABS 0h00m00
▼ 001:File Name_1.wav
002:File Name_2.wav
003:File Name_3.wav
004:File Name_4.wav
005:File Name_5.wav
```

- (3) **Use the [+] or [-] key to select the desired file and press the [MENU/ENTER] key.**  
The display now shows the file menu.

- (4) **While "Locate" is highlighted, press the [MENU/ENTER] key.**  
The display now shows the Home screen, on which you can see the recorder stops at the beginning of the selected file.

```
MENU▶File▶F002
▼ Locate ▶
Rename ▶
Remove ▶
Prev.Insert ▶
Next.Insert ▶
```

See also page 80 for details about how to select an audio file.

### Cueing playback

During playback, pressing the [F FWD] (or [REW]) key enters the cueing mode. In this mode, you can hear the playback sound at up to twice the normal speed in the forward direction or at the normal speed in the reverse direction.

### Skip/locate functions

The FR-2LE offers comprehensive locate functions.

#### Skipping by file

When more than one audio file is created on a memory card, you can immediately skip to the beginning (ABS 0) of a desired track.

When the recorder is stopped, pressing the [PREV] / [◀◀] or [NEXT] / [▶▶] key skips forward or backward a file. Therefore, by pressing the [PREV] / [◀◀] or [NEXT] / [▶▶] key as many times as required, you can skip to the beginning of the desired file.

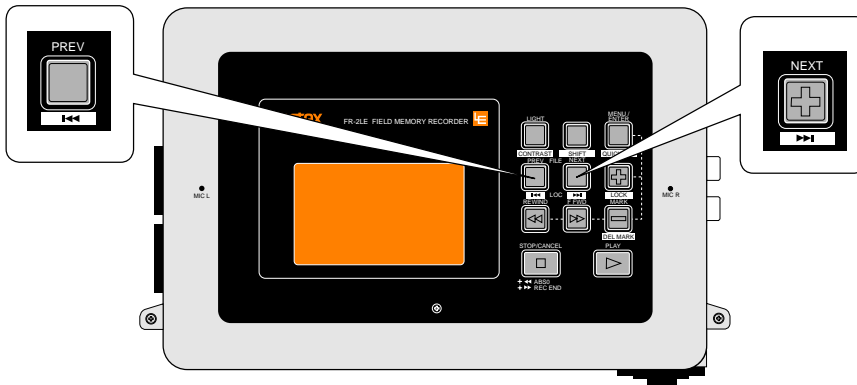

#### Skipping by cue point

You can immediately skip to a desired cue point on the current audio file. By pressing the [PREV] / [◀◀] or [NEXT] / [▶▶] key while holding down the [SHIFT] key when the recorder is stopped, you can skip to the next or previous cue point. Therefore, by pressing the [PREV] / [◀◀] or [NEXT] / [▶▶] key as many times as required, you can skip to the desired cue point.

**<Note>**: With an MP3 audio file, this function is not available.

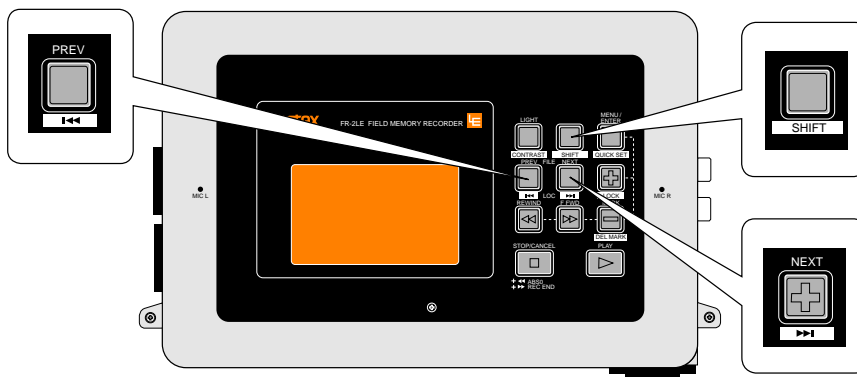

## Locating to the beginning (ABS 0) of a file

When the recorder is stopped, pressing the [REWIND] key while holding down the [STOP/CANCEL] key immediately locates to the beginning (ABS 0) of a file.

**<Note>**: When there is more than one audio file, the unit locates the beginning of the first recorded audio file.

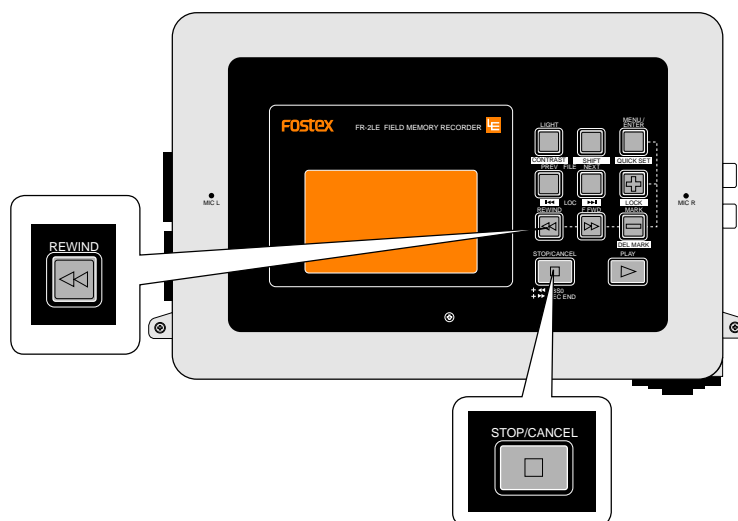

## Locating to the end (REC END) of a file

When the recorder is stopped, pressing the [F FWD] key while holding down the [STOP/CANCEL] key immediately locates to the record end position (REC END) of a file.

**<Note>**: When there is more than one audio file, the unit locates the last recording position of the most recently recorded audio file.





## Chapter 6: Exporting audio files to a PC

This chapter describes how to export audio files created by the FR-2LE to your PC.

### <Table of contents>

<b>Connecting the FR-2LE to a PC .....</b>	<b>70</b>
USB connection between the FR-2LE to a PC .....	71
Copying an audio file to a PC hard disk .....	72
Copying a file from a PC to a memory card .....	72
Example of exporting audio data to a PC software application .....	73
<b>Protecting a memory card .....</b>	<b>76</b>

## Connecting the FR-2LE to a PC

USB connection between the FR-2LE and your PC allows you to transfer audio (BWF) files created by the FR-2LE.

FR-2LE audio data can be copied to a hard disk on your PC, or exported to a computer application such as Digidesign Pro Tools.

To make USB connection, connect the [USB] port of the FR-2LE to the [USB] port of your PC using a USB cable (note that a USB cable is not supplied with the unit), and set the "USB Mode" menu in the MENU mode appropriately (see the operation procedure below).

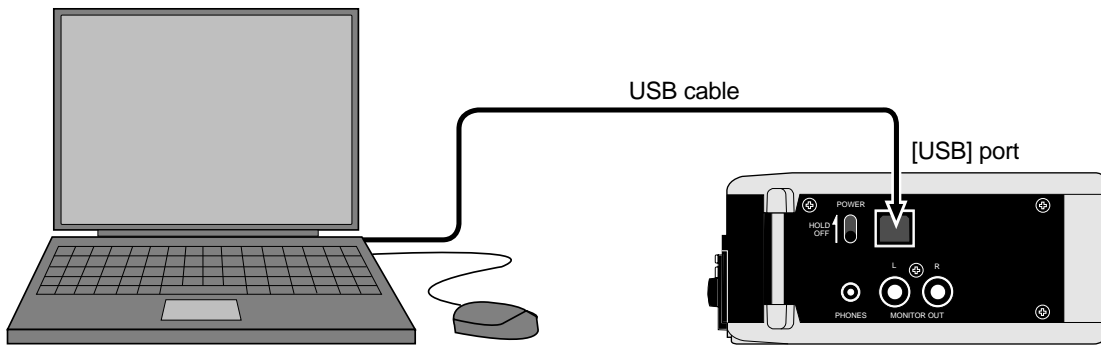

### <Note on using the FR-2LE with a PC>

- When you use the FR-2LE with your PC, operate the FR-2LE on the AC adaptor in order to supply the stable power to the FR-2LE.
- For transferring audio files, you only can use a PC which runs Windows ME, 2000 or XP OS and supports USB connection.  
Note that you cannot use a Macintosh computer or any computer which does not run the OS above. Make sure that your PC can be used with the FR-2LE before making connection.
- Even if your Windows PC does not provide a USB connector, you can make backup copy of data on a memory card by using a commercially available card reader for CFC.

- All company names and model names mentioned in this manual are trademarks or registered trademarks of their respective holders.

### <Protection of a memory card>

The "USB Mode" menu in the MENU mode provides the "Card Protect" item which enables or disables the protection of a memory card. When you transfer an audio file between the FR-2LE and your PC, it is recommended to enable the protection in order to protect audio files on the memory card of the FR-2LE (see page 76 for details).

## USB connection between the FR-2LE to a PC

The following description shows how to make USB connection between the FR-2LE to a Windows ME machine.

- 1) Turn on the power of both the PC and FR-2LE.
- 2) Press the [MENU/ENTER] key of the FR-2LE to enter the MENU mode. The display shows the first layer of the MENU mode screen.

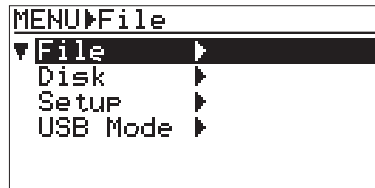

- 3) Use the [-] key to select "USB Mode >" at the bottom and press the [MENU/ENTER] key. The display now shows the USB Mode screen. You can now select an item of the USB mode menu.

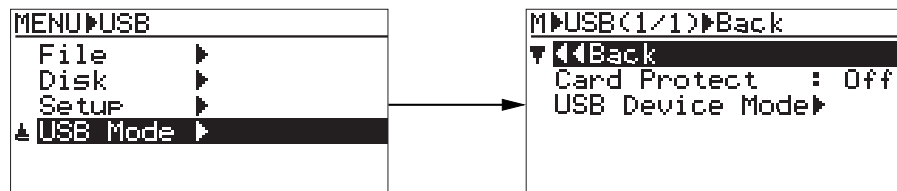

- 4) Use the [-] key to select "USB Device Mode >" at the bottom and press the [MENU/ENTER] key.

The FR-2LE enters the USB mode and the display shows the screen on the right below. While this screen is shown, you can transfer data between the FR-2LE and the PC.

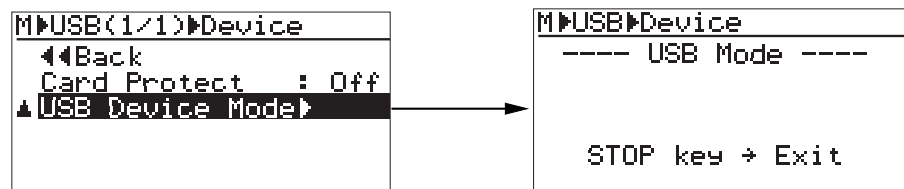

**<Note>:** While the FR-2LE is in the USB mode, all controls (keys, switches, etc.) on the FR-2LE panel except the [STOP/CANCEL] key are disabled.

- 5) Use a USB cable to connect the FR-2LE to the PC.

### Copying an audio file to a PC hard disk

- 1) **By opening "My computer" on the PC, a drive named "Removable disk" is added to the PC.**  
The first time you connect the FR-2LE to the PC, the disk driver is installed.
- 2) **Open the removable disk drive newly added and select a desired audio file in the appropriate folder, and then copy it to the PC.**  
When opening the removable disk drive newly added, all audio files stored to the memory card are shown.  

**<Note>:** When a file is "copied", the original file on the memory card remains. When a file is "moved", the original file on the memory card disappears.
- 3) **After transferring the file, disconnect the FR-2LE from the PC.**  

**<Note>:** To disconnect the FR-2LE from the PC after exporting the file data, make sure that the [ACCESS] indicator is unlit, and follow the instructions of the Windows "Safely Remove Hardware" application.
- 4) **Press the [STOP/CANCEL] key to exit the USB mode.**  
When exiting the USB mode, the unit exits the MENU mode.

### Copying a file from a PC to a memory card

You can copy a file from a PC to a memory card on the FR-2LE. This function is useful when upgrading the FR-2LE. In such a case, download the file for upgrading the FR-2LE from the Fostex web site to your PC, and copy it to a memory card. In the following procedure, it is assumed that the file for upgrading the FR-2LE has been already downloaded to your PC (see page 111 for details about upgrading the software).

**<Note>:** Before you copy data from your PC to a memory card, make sure that the card is not protected. If it is protected, you cannot copy data.

- 1) **By opening "My computer" on the PC, a drive named "Removable disk" is added to the PC.**  
The first time you connect the FR-2LE to the PC, the device driver is installed.
- 2) **Copy the file for upgrading the FR-2LE to the "Root folder" on the added removable drive.**  

**<Note>:** When a file is "copied" to the "Root folder", the original file on the PC hard drive remains. When a file is moved to the "Root folder", the original file disappears.
- 3) **After copying the file, disconnect the FR-2LE from the PC.**  

**<Note>:** When you disconnect the FR-2LE from the PC after exporting the file, unmount the removable disk drive before removing the USB cable.
- 4) **Press the [STOP/CANCEL] key to exit the USB mode.**  
When exiting the USB mode, the unit exits the MENU mode.



## Example of exporting audio data to a PC software application

The following procedure example shows how to export FR-2LE audio data to Digidesign Pro Tools for Windows.

For details about instructions of Pro Tools, see the instruction manual supplied with Pro Tools. (Note that the display examples shown here may be different from those you see on your PC.)

- 1) Start up Pro Tools on your PC.
- 2) Click on "Audio" in the Pro Tools window to bring up the popup menu of the audio region list (see arrow 1 below).
- 3) From the popup menu, select the "Import Audio" item (see arrow 2 below).

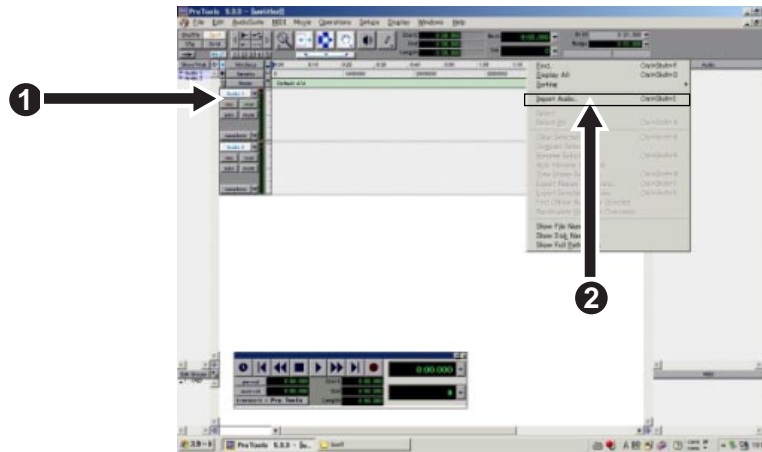

- 4) Select "CFC000" on the desktop (see arrow 3 below).  
The disk volume label in the example below shows a tentative volume label which is given by default. If the tentative (default) volume label of the memory card has been edited using the "Reel No." menu item on the "Disk" menu in the MENU mode, the edited label is shown.

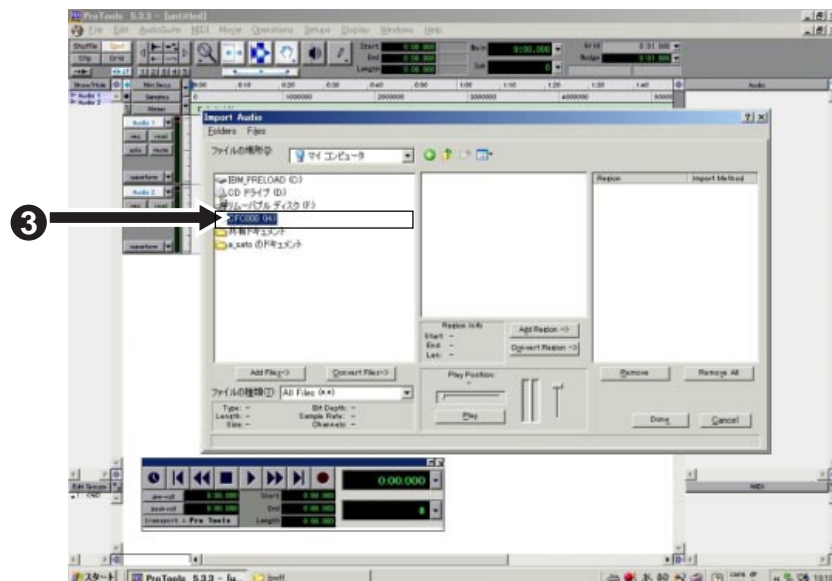

- 5) **Select a desired audio file in the "bwff" directory on the card (see arrow 4 below).**  
The selected audio file is shown in "Region in current file".
- 6) **Click on "Convert ->", followed by "Done" (see arrow 5 below).**  
The display shows the window for selecting a folder for storing the file.

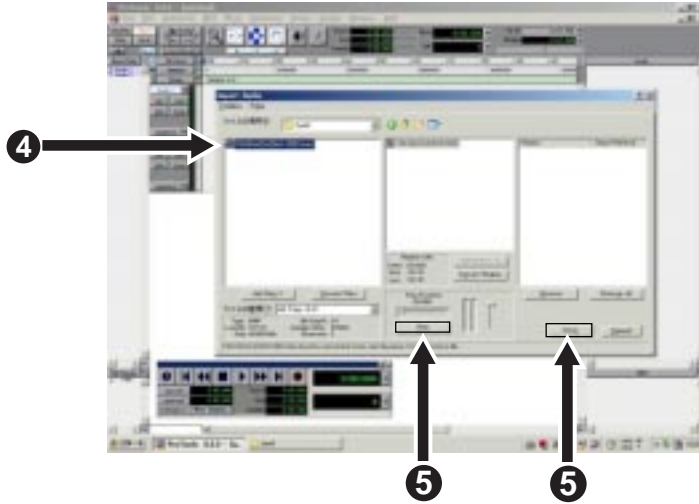

- 7) **Select a desired destination folder for storing the file and click on "Select" (see arrow 6 below).**  
The PC starts storing the selected file to the folder.

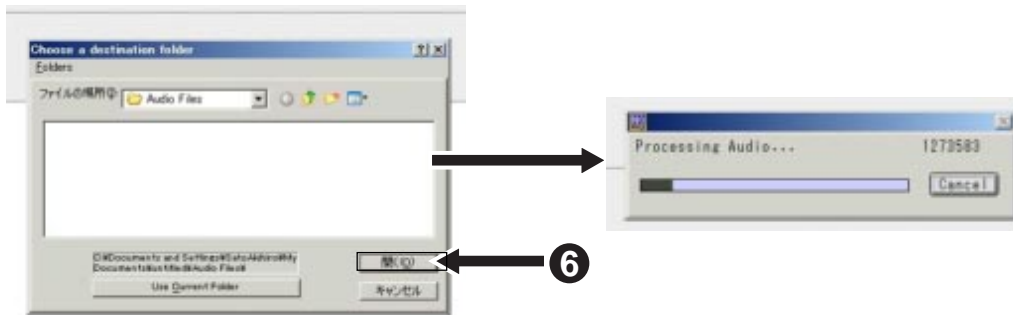

The stored file is displayed in the audio region list (see arrow 7 below).

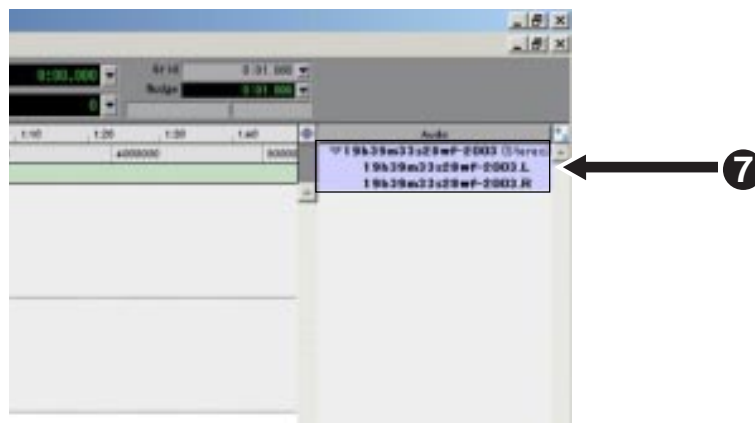

- 8) Enable "Spot" and drag & drop the audio region list to the track area (see arrow 8). The "Spot Dialog" window appears.

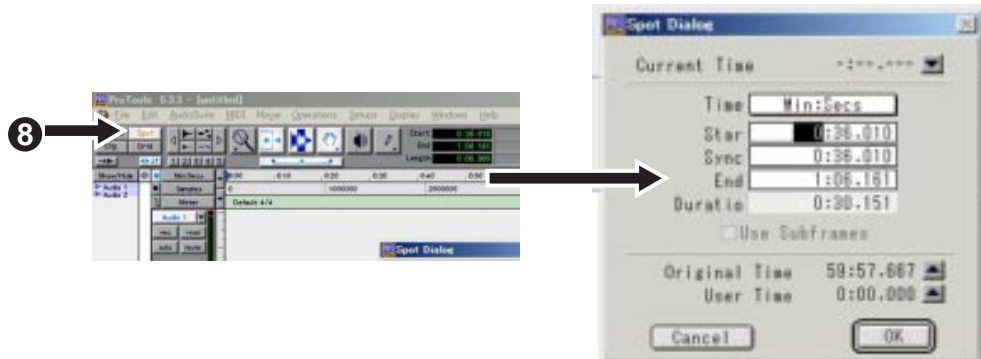

- 9) Click on "▲" in the "Spot Dialog" window, followed by "OK" (see arrow 9 below). Clicking on "▲" sets the "Original Time Stamp" time to the "Start" time. Then clicking on "OK" imports audio data from the specified position.

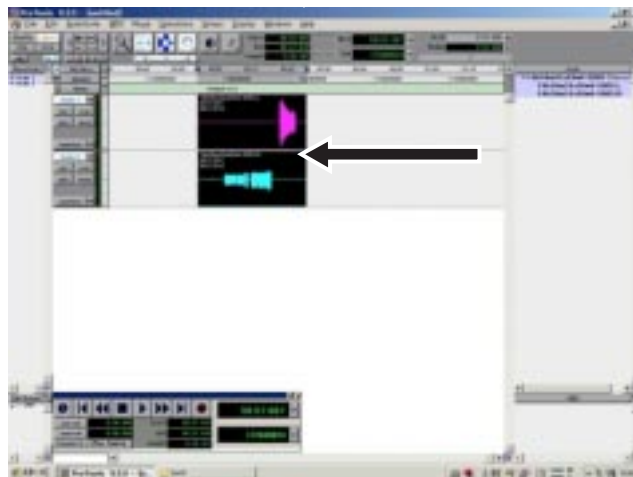
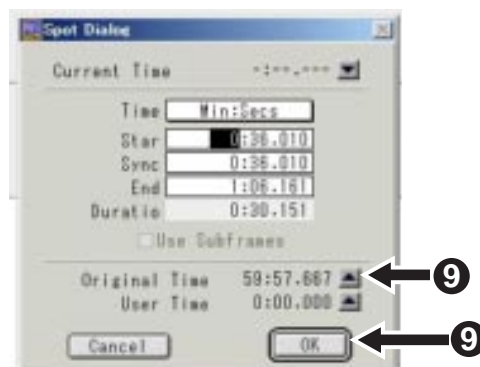

# Protecting a memory card

You can protect a memory card. The protection setting is effective only while the unit is in the USB mode. When a card is protected, you can read the card but cannot write data to the card in the USB mode.

There may be a risk of destroying audio files on the FR-2LE by copying file data from a PC to the FR-2LE by mistake. To prevent this kind of an accident, we recommend protecting a memory card in use.

- 1) Turn on the power of both the PC and FR-2LE.
- 2) Press the [MENU/ENTER] key of the FR-2LE to enter the MENU mode.  
The display shows the main menu in the MENU mode.

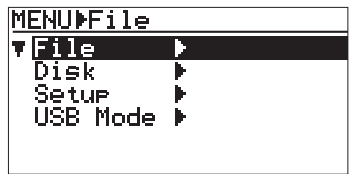

- 3) Use the [-] key to select "USB Mode" at the bottom and press the [MENU/ENTER] key.  
The display now shows the USB Mode screen. You can now select an item of the USB mode menu.

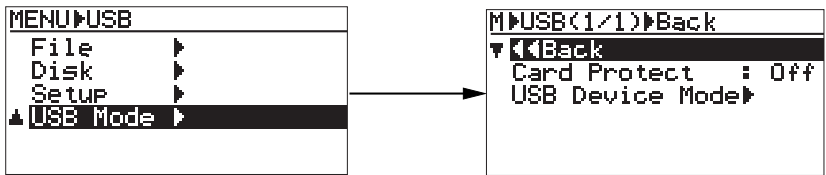

- 4) Use the [-] key to select "Card Protect" and press the [MENU/ENTER] key.  
The current setting starts flashing (by default, "Off" flashes) and you can now change the setting.

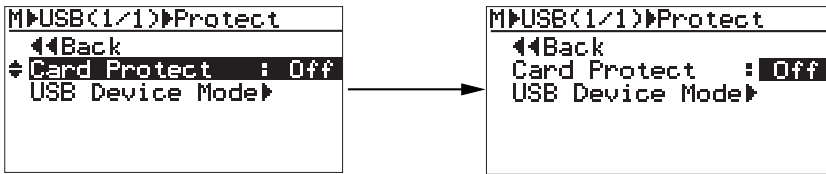

- 5) Use the [-] key to select "On" and press the [MENU/ENTER] key.  
The card is now protected and the display returns to show the previous screen. To release the card protection, carry out the similar procedure as above.

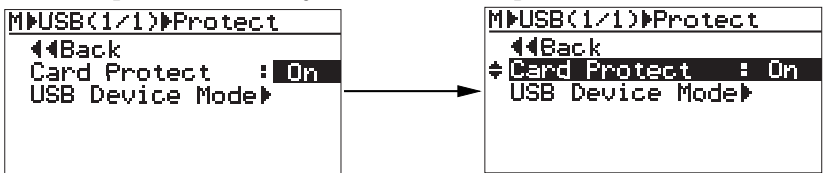

<b>On</b>	You can only export FR-2LE data to a PC.
<b>Off (default)</b>	You can export FR-2LE data to a PC as well as import data from a PC.

- 6) Press the [STOP/CANCEL] key to exit the USB mode.

# Chapter 7: MENU mode

## <Table of contents>

<b>How to operate in the MENU mode</b> .....	<b>78</b>
Menu items .....	79
<b>File menu</b> .....	<b>80</b>
Selecting an audio file to be played back (Select) .....	80
Renaming the file name of the selected file (Rename) .....	81
Removing a file from the ADL (Remove) .....	83
Restoring a removed file to the ADL (Prev.Insert/Next Insert) .....	84
<b>Disk menu</b> .....	<b>86</b>
Formatting a memory card (Format) .....	86
Editing a reel number of a memory card (Reel No) .....	89
Resume function on/off (Resume) .....	90
<b>Setup menu</b> .....	<b>91</b>
ALC (Auto Level Control)/limiter on/off (ALC) .....	91
HPF (High Pass Filter) on/off (HPF) .....	92
Selecting default Fs/Bit (Def.FS/BIT) .....	93
Input source (internal mic/external) selection (Source Sel) .....	94
Phantom power on/off (Phantom) .....	95
Monitor output mode (Monitor Mode) .....	96
Internal speakers on/off (Speaker Out) .....	97
Selecting the default file name type (File Name Mode) .....	98
Setting the default file name (Default File Name) .....	99
Pre rec mode on/off (Pre Rec) .....	102
Selecting time display mode (Time Display) .....	103
Selecting remaining display mode (Remain Display) .....	104
Setting the maximum file size (Max File Size) .....	105
Selecting battery type (Battery Type) .....	106
Error tone output on/off (Error Tone) .....	107
Adjusting the real time clock (Adjust Real Time) .....	108
Checking the ROM version (Version) .....	109
Initializing settings of the Setup menu (Initial Setup) .....	110
Software version up (Version up) .....	111

## How to operate in the MENU mode

- 1) To enter the MENU mode, press the [MENU/ENTER] key while the recorder is stopped. The display shows the main menu screen.

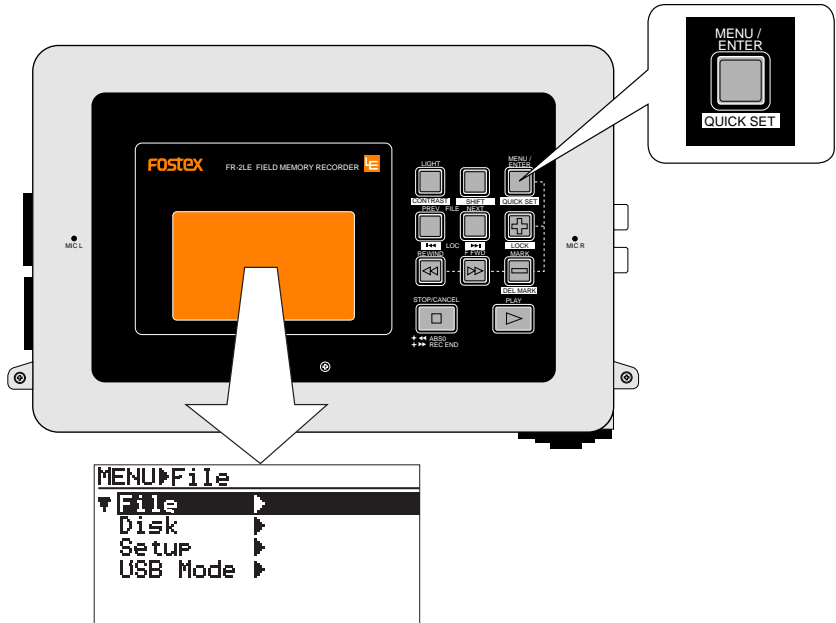

- 2) Use the [+] or [-] key to select a desired menu. Pressing the [+] key moves up the cursor, while pressing the [-] key moves down the cursor.

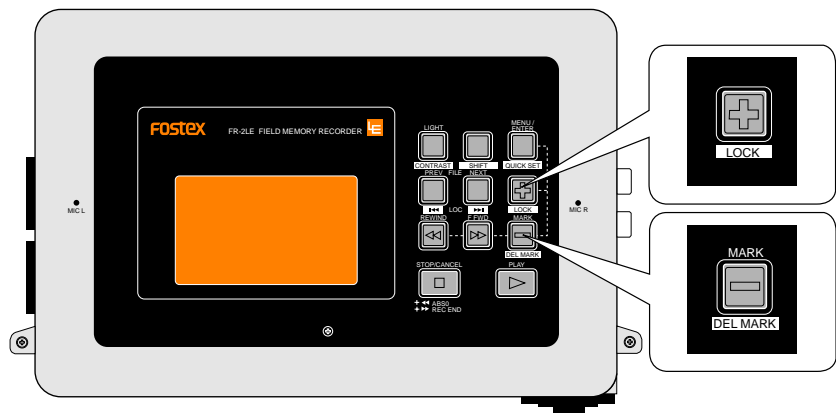

- 3) After selecting the desired menu, press the [MENU/ENTER] key to bring up the screen for selecting the menu item of the selected menu (see <Note> below).
- 4) After selecting the menu item, make setting of the item.

**<Note>**: When you select the Disk, Setup or USB Mode menu in step 2) above, executing step 3) brings up the screen for selecting the menu item. When you select the File menu in step 2), executing step 3) brings up the screen for selecting an audio file in the ADL. See "File menu" described later for details.

## Menu items

Menu item	Function
<p>File menu item</p> <pre> MENU▶File▶F002 ▼Locate ▶ Rename ▶ Remove ▶ Prev.Insert ▶ Next Insert ▶                     </pre>	<ul style="list-style-type: none"> <li>• Locates the beginning of the selected file.</li> <li>• Renames the file name of a selected file.</li> <li>• Removes a file from the ADL.</li> <li>• Restores a removed file to the ADL.</li> </ul>
<p>Disk menu item</p> <pre> MENU▶Disk▶Format ▼Format ▶ Reel No ▶ Resume : Off                     </pre>	<ul style="list-style-type: none"> <li>• Formats (initializes) a memory card.</li> <li>• Edits the reel number of a memory card.</li> <li>• Enables or disables the resume function.</li> </ul>
<p>Setup menu item</p> <pre> MENU▶Setup▶ALC ▼ALC : Off HPF : Off Def.FS/BIT: BWF44/16 Source Sel : INPUT Phantom : Off MonitorMode:L/R Speaker Out: On FileNameMode:Date Default File Name ▶ Pre Rec : Off Time Display : ABS RemainDisplay: Time Max File Size: 2GB Battery Type : NiMH Error Tone : Off AdjustRealTimeClock▶ Version ▶ Initial Setup▶ Version Up ▶                     </pre>	<ul style="list-style-type: none"> <li>• Enables or disables the ALC/limiter functions.</li> <li>• Enables or disables the HPF</li> <li>• Selects the default recording format (FS/BIT) when formatting a card.</li> <li>• Enables or disables the phantom power.</li> <li>• Selects the monitor output mode.</li> <li>• Enables or disables the internal speaker.</li> <li>• Selects the file name mode for a file created when recording.</li> <li>• Sets the default file name when the file name mode is set to "Take".</li> <li>• Enables or disables the pre record mode.</li> <li>• Selects the time display mode.</li> <li>• Selects the remaining display mode.</li> <li>• Sets the maximum file size.</li> <li>• Selects the battery type for power supply.</li> <li>• Enables or disables the error tone output.</li> <li>• Adjusts the realtime clock.</li> <li>• Viewing the ROM version.</li> <li>• Initializes the Setup menu settings.</li> <li>• Upgrades the software.</li> </ul>
<p>USB mode menu item</p> <pre> M▶USB(1/1)▶Back ▼◀◀Back Card Protect : Off USB Device Mode▶                     </pre>	<ul style="list-style-type: none"> <li>• Enables or disables memory card protection.</li> <li>• Enables or disables the USB device mode.</li> </ul>

## File menu

Using the File menu, you can do the following regarding audio files.

1. Locates the beginning of the selected file.
2. Renames the file name of a selected file.
3. Removes a file from the ADL.
4. Restores a removed file to the ADL.

**<Note>:** To use the File menu, at least one audio file must be stored to the current memory card. Otherwise, "<No Entries>" is shown.

**<Notes>**

- An audio file created by the FR-2LE is automatically added to the ADL (Audio Decision List). You can continuously play back the files in the ADL in the order of creation. You can also locate the beginning of the desired audio file, as well as edit the file name.
- You can delete a desired audio file from the ADL, as well as restore the deleted file to the desired position in the ADL.
- An audio file in the ADL is called "playback file". An audio file deleted from the ADL is called "free file".

### Locating the beginning of the selected file (Locate)

You can locate the beginning of a desired audio file in the ADL. In the following description, it is assumed that the FR-2LE is in the MENU mode and the main menu screen is shown ("File >" is highlighted).

**<Note>:** You cannot locate the beginning of a free file (an audio file removed from the ADL). See "Removing a file from the ADL" on page 82 for details about removing a file.

**<Hint>:** You can also locate the beginning of an audio file by using the [PREV] / [◀◀] or [NEXT] / [▶▶] key (see page 65).

- 1) While "File >" is highlighted, press the [MENU/ENTER] key.

The display now shows the playback files in the ADL.

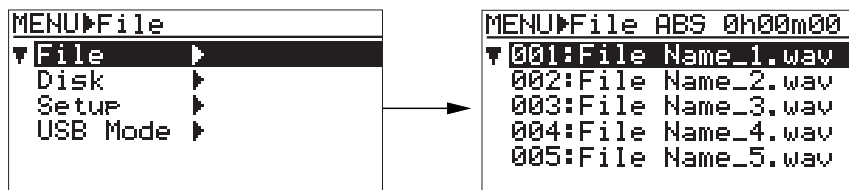

- 2) Use the [+] or [-] key to select a desired file and press the [MENU/ENTER] key.

The file is selected and the display changes to show the screen for selecting a file menu item. In the screen example below, File 002 is selected.

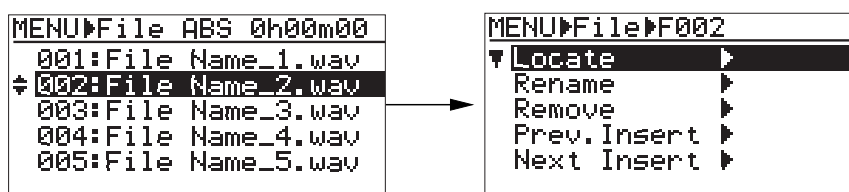



- While "Locate" is highlighted, press the [MENU/ENTER] key.  
After popping up "Please Wait", the display changes to show the Home screen of the selected audio file. In the Home screen example below, the time display mode is set to "PRG" (in this mode, the beginning of an audio file is always "00h00m00s").

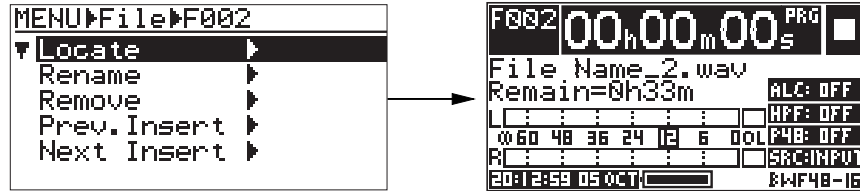

## Renaming the file name of the selected file (Rename)

You can rename an audio file in the ADL.

In the following description, it is assumed that the FR-2LE is in the MENU mode and the main menu screen is shown ("File >" is highlighted).

**<Note>**: You cannot rename an audio file which is removed from the ADL (see "Removing a file from the ADL" on page 82 for details about removing a file).

- While "File >" is highlighted, press the [MENU/ENTER] key.  
The display now shows the playback files in the ADL.

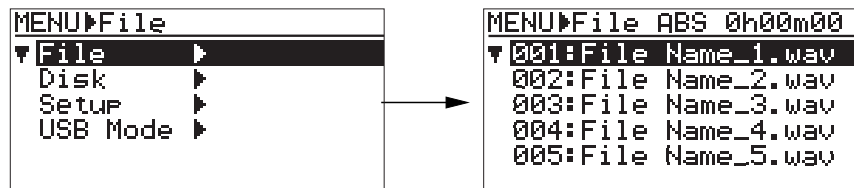

- Use the [+] or [-] key to select a desired file and press the [MENU/ENTER] key.  
The file is selected and the display changes to show the screen for selecting a file menu item. In the screen example below, File 002 is selected.

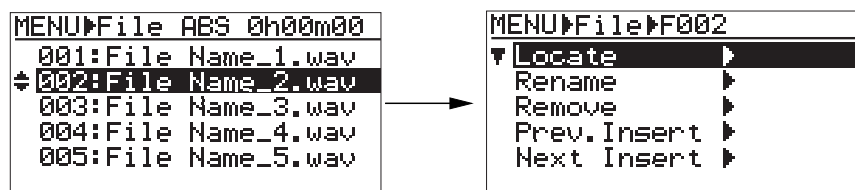

- Use the [+] or [-] key to select "Rename >", and press the [MENU/ENTER] key.  
The display now shows the editing screen as below, on which you can edit the file name.

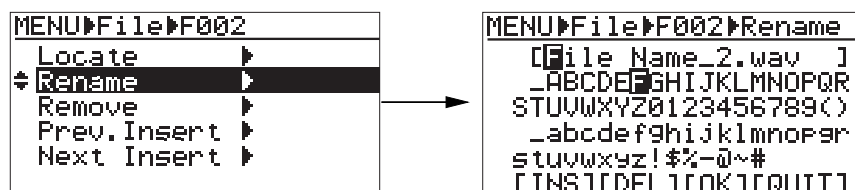

**<How to enter a file name>**

The cursor in [ ] at the top on the editing screen is called "file name cursor", while the cursor in the character selection area is called "character selection cursor".

You can move the file name cursor by using the [REWIND] or [F FWD] key, while you can move the character selection cursor by using the [+] or [-] key. By pressing and holding down the [+] or [-] key, the cursor moves fast.

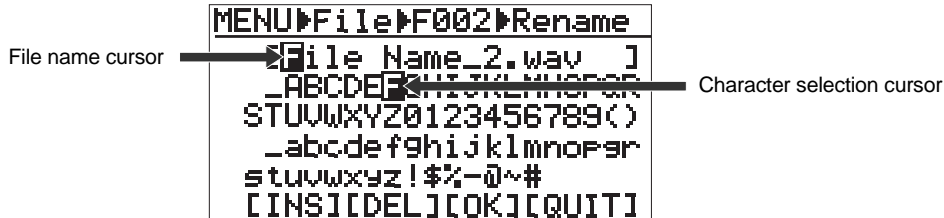

At the bottom of the screen, the following four functions are available.

- [INS]: Inserts a space at the right of the file name cursor position.
- [DEL]: Deletes a character on the file name cursor position.
- [OK]: Fixes the file name entered.
- [QUIT]: Quits the file name editing.

**<Example of file name entry>**

- 1) Use the [REWIND] or [F FWD] key to move the file name cursor to the position where you can edit.
- 2) Use the [+] or [-] key to move the character selection cursor to the desired character.
- 3) Repeat the steps 1) and 2) above until you complete entering the desired file name. The maximum length of a file name string is 19 characters.

**<How to delete a character>**

- 1) Use the [REWIND] or [F FWD] key to move the file name cursor to the character you want to delete.
- 2) Use the [+] or [-] key to move the character selection cursor to "[DEL]".
- 3) Press the [MENU/ENTER] key to delete the selected character. All characters on the right of the deleted character are shifted to the left.

**<Hint>**: If you move the reel number cursor to the leftmost character in step 1), you can delete a whole file name by repeating step 3) as many times as required.

**<How to insert a character>**

- 1) Use the [REWIND] or [F FWD] key to move the file name cursor to the position where you want to insert a character.
- 2) Use the [+] or [-] key to move the character selection cursor to "[INS]".
- 3) Press the [MENU/ENTER] key.
- 4) Use the [+] or [-] key to select a desired character to be inserted.

- 4) When you finish entering the desired file name, press the [MENU/ENTER] key to store the file name.

The unit starts the operation for storing the entered name.

When completed, "Completed!" is shown on the screen and the display returns to show the playback files (see next page).

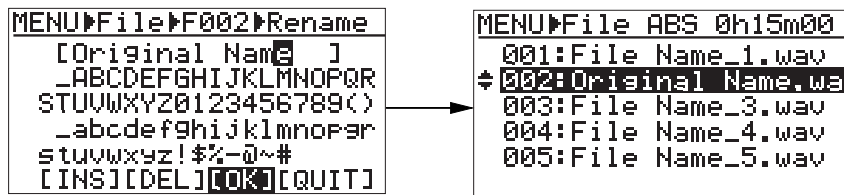

**<Hint>**: You can also store the file name by using the [+] or [-] key to move the character selection cursor to "[OK]", and pressing the [MENU/ENTER] key.

**<Note>**: If you attempt to store a file name which already exists on the card, "Same name exist!" flashes on the display and you cannot store the name. If you attempt to store an illegal name, "Illegal name!" flashes on the display and the operation is canceled.

- 5) Press the [STOP/CANCEL] key to exit the MENU mode.

## Removing a file from the ADL (Remove)

You can remove (delete) an audio file from the ADL.

In the following description, it is assumed that the FR-2LE is in the MENU mode and the main menu screen is shown ("File >" is highlighted).

**<Notes>**

- An audio file removed from the ADL remains on the memory card as a "free file", though you cannot play it back or edit its file name. To play back a free file or edit its file name, restore it to the ADL again using the "Prev. Insert" or "Next Insert" item.
- If you format the memory card using the "Format" item on the "Disk" menu, all audio files on the memory card are erased.

- 1) While "File >" is highlighted, press the [MENU/ENTER] key. The display now shows the playback files in the ADL.

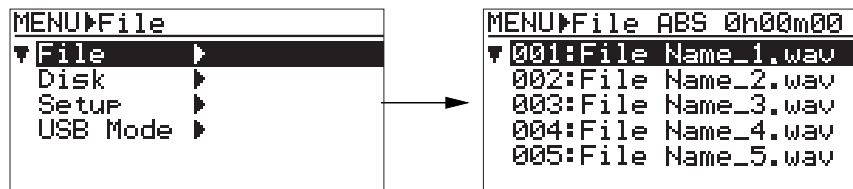

- 2) Use the [+] or [-] key to select a file you want to remove and press the [MENU/ENTER] key. The file is selected and the display changes to show the screen for selecting a file menu item. In the screen example below, File 002 is selected.

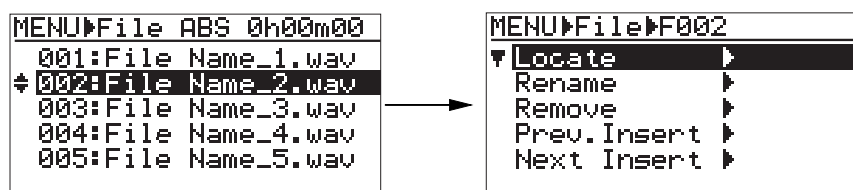

- 3) Use the [+] or [-] key to select "Remove >", and press the [MENU/ENTER] key.  
 The selected audio file is removed from the ADL and remains on the card as a "free file".  
 The display returns to show the playback files. The files following the removed file move up in the ADL.

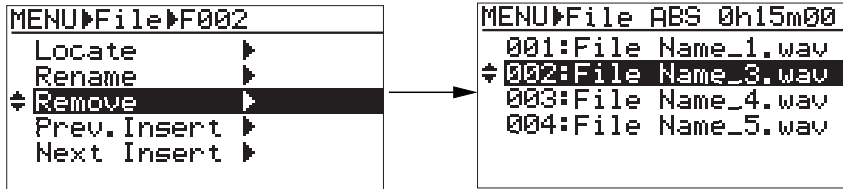

- 4) Press the [STOP/CANCEL] key to exit the MENU mode.

### Restoring a removed file to the ADL (Prev. Insert/next Insert)

You can restore a free file (removed audio file) to the previous or next position of a desired file in the ADL. The restored audio file can be played back, as well as its file name can be edited. In the following description, it is assumed that:

- the FR-2LE is in the MENU mode and the main menu screen is shown ("File >" is highlighted).
- there are five playback files in the ADL, while there are three free files.

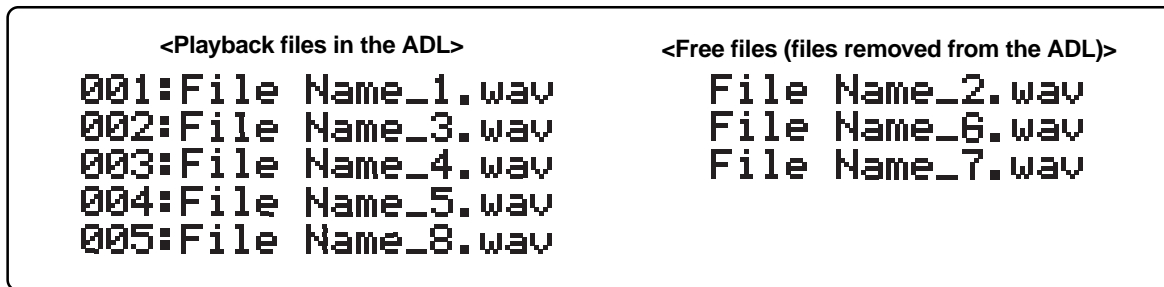

- 1) While "File >" is highlighted, press the [MENU/ENTER] key.  
 The display now shows the playback files in the ADL.

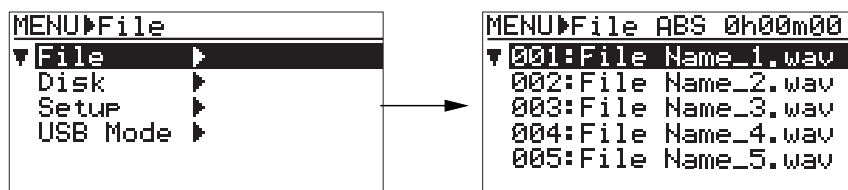

- 2) Use the [+] or [-] key to select the audio file at the position where you want to restore a remove audio file, and press the [MENU/ENTER] key.  
 The file is selected and the display changes to show the File menu screen. In the screen example below, File 002 is selected.

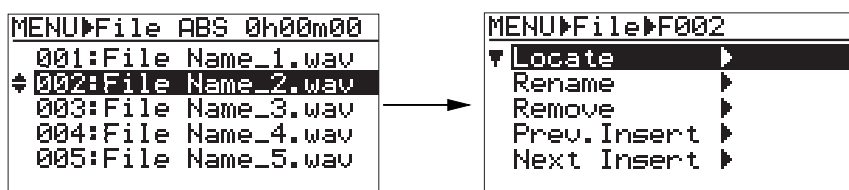

- 3) Use the [+] or [-] key to select "Prev. Insert" or "Next Insert", and press the [MENU/ENTER] key. If you attempt to insert a free file to the previous position of the audio file selected in step 2), select "Prev. Insert". If you attempt to insert a free file to the next position of the audio file selected in step 2), select "Next Insert".

Pressing the [MENU/ENTER] key after selecting "Prev. Insert" or "Next Insert" brings up the free file list on which you can view all audio files removed from the ADL.

- If you want to insert a free file to the previous position of the selected audio file (When selecting "Prev. Insert"):

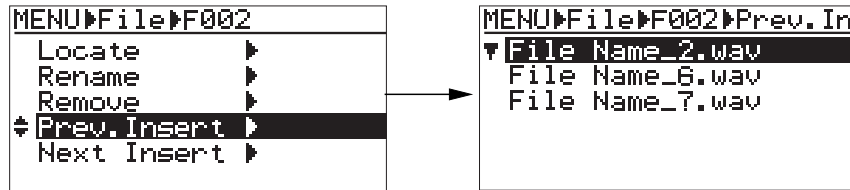

- If you want to insert a free file to the next position of the selected audio file (When selecting "Next Insert"):

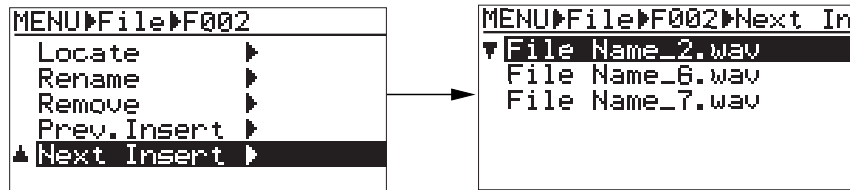

**<Note>:** If there is no free file, "No free files" is popped up and the free file list is not shown.

- 4) Use the [+] or [-] key to select a free file you want to restore, and press the [MENU/ENTER] key. The selected free file is inserted to the previous or next position (depending in step 3) above) of the audio file you selected in step 2).

- If you insert "File Name\_7.wav" to the previous position of file 002.

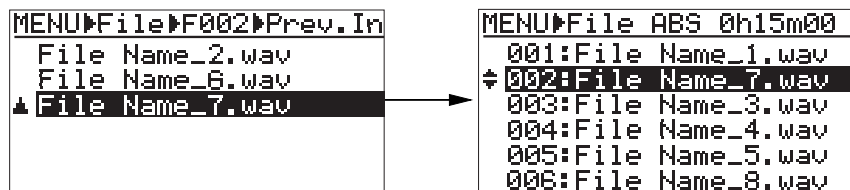

- If you insert "File Name\_6.wav" to the next position of file 002.

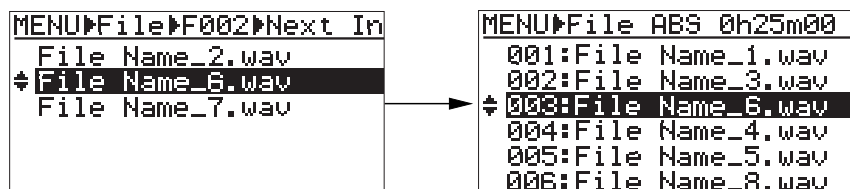

- 5) Press the [STOP/CANCEL] key to exit the MENU mode.

The display returns to the Home screen of the file which has been loaded before entering the MENU mode.

## Disk menu

Using the Disk menu, you can do the following regarding a memory card.

1. Formats a memory card.
2. Edits the reel number of a memory card.
3. Enables or disables the resume function.

**<Note>:** To carry out operations for a Disk menu item, a memory card must be set to the unit.

### Formatting a memory card (Format)

The FR-2LE can format the current memory card with the FAT32 (File Allocation Table 32) file system. In the following description, it is assumed that the FR-2LE is in the MENU mode and the main menu screen is shown ("File >" is highlighted).

- 1) Use the [+] or [-] key to select "Disk >" and press the [MENU/ENTER] key. The display now shows the Disk menu.

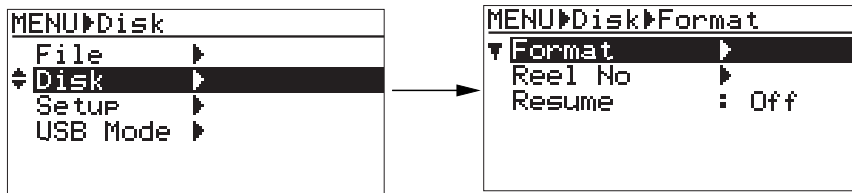

- 2) While "Format >" is highlighted, press the [MENU/ENTER] key. The display now shows the format mode screen. You can edit the reel number and select the FS/BIT mode on this screen.

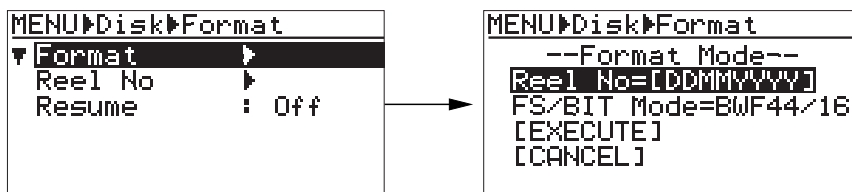

- 3) Use the [+] or [-] key to select "Reel No >" and press the [MENU/ENTER] key. The display now shows the screen for editing the reel number, on which the first character of the current reel number flashes. See next page for details about how to edit the reel number.

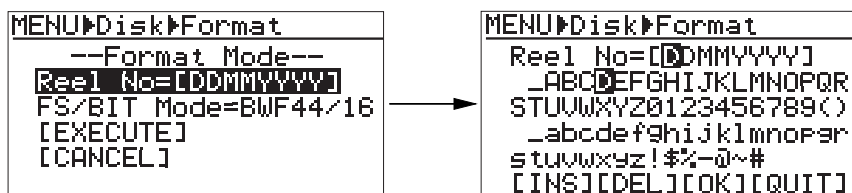

**<How to enter a reel number>**

The cursor in [ ] at the top on the editing screen is called "reel number cursor", while the cursor in the character options is called "character selection cursor".

You can move the reel number cursor by using the [REWIND] or [F FWD] key, while you can move the character selection cursor by using the [+] or [-] key. By pressing and holding down the [+] or [-] key, the cursor moves fast.

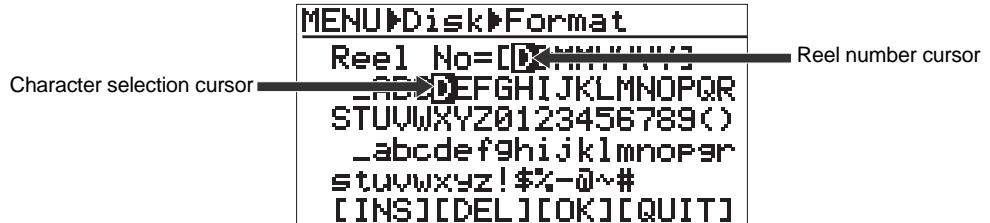

At the bottom of the screen, the following four functions are available.

- [INS]: Inserts a space at the right of the reel number cursor position.
- [DEL]: Deletes a character on the reel number cursor position.
- [OK]: Fixes the reel number entered.
- [QUIT]: Quits the reel number editing.

**<Example of reel number entry>**

- 1) Use the [REWIND] or [F FWD] key to move the reel number cursor to the position where you can edit.
- 2) Use the [+] or [-] key to move the character selection cursor to the desired character.
- 3) Repeat the steps 1) and 2) above until you complete entering the desired reel number. The maximum length of a reel number string is 8 characters.

**<How to delete a character>**

- 1) Use the [REWIND] or [F FWD] key to move the reel number cursor to the character you want to delete.
- 2) Use the [+] or [-] key to move the character selection cursor to "[DEL]".
- 3) Press the [MENU/ENTER] key to delete the selected character. All characters on the right of the deleted character are shifted to the left.

**<Hint>**: If you move the reel number cursor to the leftmost character in step 1), you can delete a whole reel number by repeating step 3) as many times as required.

**<How to insert a character>**

- 1) Use the [REWIND] or [F FWD] key to move the reel number cursor to the position where you want to insert a character.
- 2) Use the [+] or [-] key to move the character selection cursor to "[INS]".
- 3) Press the [MENU/ENTER] key.
- 4) Use the [+] or [-] key to select a desired character to be inserted.

- 4) After editing the reel number, press the [MENU/ENTER] key.

The edited reel number is set and the display shows the lower right screen..

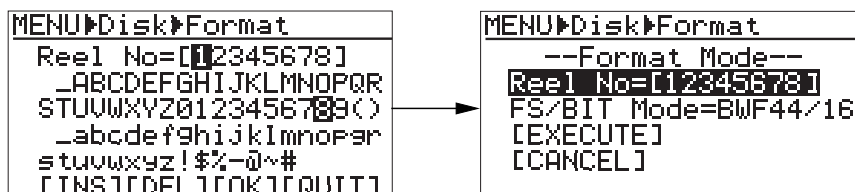

- 5) Press the [-] key to highlight "FS/BIT Mode" and press the [MENU/ENTER] key. Now you can select the FS/BIT mode.

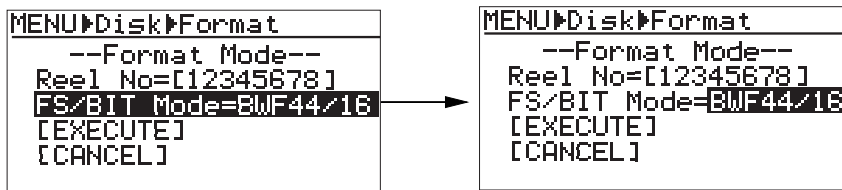

- 6) Use the [+] or [-] key to select the desired FS/BIT mode and press the [MENU/ENTER] key. The selected FS/BIT mode is set and the display changes to show the lower right screen.

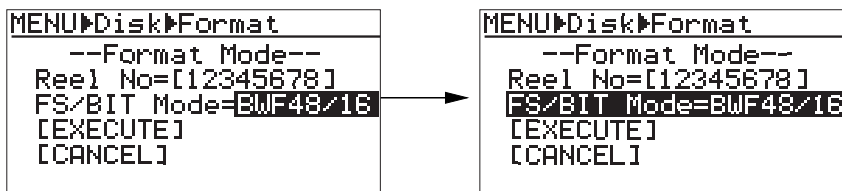

You can select the desired FS/BIT mode from among the following modes using the [+] or [-] key.

- BWF44/16 (44.1kHz/16Bit, BWF file mode)
- BWF48/16 (48kHz/16Bit, BWF file mode)
- BWF44/24 (44.1kHz/24Bit, BWF file mode)
- BWF48/24 (48kHz/24Bit, BWF file mode)
- BWF88/24 (88.2kHz/24Bit, BWF file mode)
- BWF96/24 (96kHz/24Bit, BWF file mode)
- MP3- 192 (192Kbps, MP3 compressed file mode)

Note that the FS/BIT mode you select here is immediately reflected to the "Default FS/BIT" item on the Setup menu and shown on the Home screen.

- 7) Press the [-] key to highlight "[EXECUTE]" and press the [MENU/ENTER] key. The lower right "caution" screen appears. "Are you sure?" is flashing on the screen.

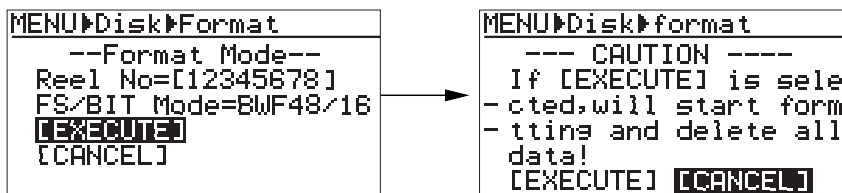

- 8) Press the [REWIND] key to highlight "[EXECUTE]" and press the [MENU/ENTER] key. The unit starts formatting the card. When completed, the display shows "Success." and the unit stops accessing the card.



- 9) Press any of the operation keys. The display shows the Home screen after formatting, where "<<No Audio Files>>" is shown.



## Editing a reel number (volume label) of a memory card (Reel No)

You can edit the default reel number which is given when a memory card is formatted.

In the following description, it is assumed that the FR-2LE is in the MENU mode and the main menu screen is shown ("File >" is highlighted).

- 1) Use the [+] or [-] key to select "Disk >" and press the [MENU/ENTER] key.  
The display now shows the Disk menu.

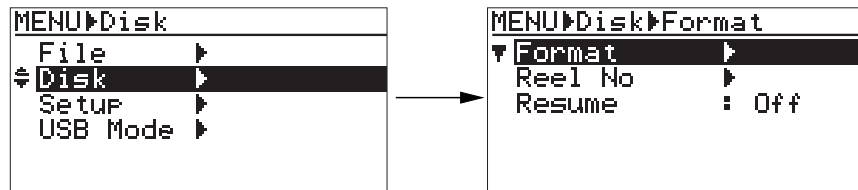

- 2) Use the [+] or [-] key to select "Reel No >" and press the [MENU/ENTER] key.  
The display now shows the screen for editing the current reel number of the memory card.

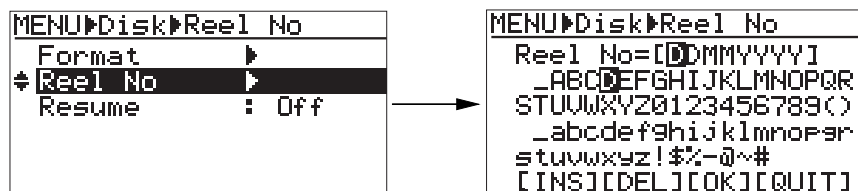

- 3) Edit the reel number according to the method described on page 87.  
The maximum length of a reel number string is eight characters.
- 4) After editing (renaming) the reel number, press the [MENU/ENTER] key to store the new reel number.

**<Note>:** If you attempt to store an illegal reel number, "Illegal name!" flashes on the display and the operation is canceled.
- 5) Press the [STOP/CANCEL] key to exit the MENU mode.

## Enabling or disabling the Resume function (Resume)

---

The FR-2LE memorizes the current playback position when you turn off the power or remove the current memory card.

If the resume function is enabled, the unit automatically locates the last memory position when you turn on the power or load the same memory card. By default, the resume function is disabled.

In the following description, it is assumed that the FR-2LE is in the MENU mode and the main menu screen is shown ("File >" is highlighted).

- 1) Use the [+] or [-] key to select "Disk >" and press the [MENU/ENTER] key.  
The display now shows the Disk menu.

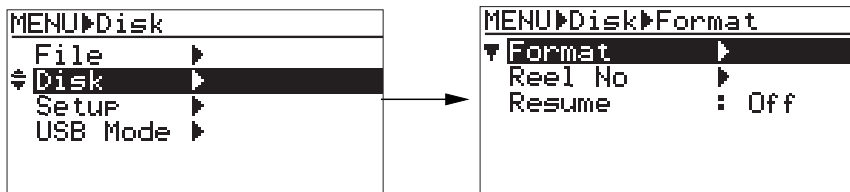

- 2) Use the [+] or [-] key to select "Resume >" and press the [MENU/ENTER] key.  
The current setting ("On" or "Off") flashes and you can now change the setting. By default, "Off" flashes.

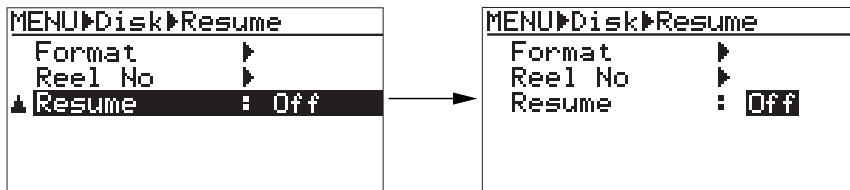

- 3) Use the [+] or [-] key to select "On" or "Off" and press the [MENU/ENTER] key.  
You completes the setting and the display changes to show the previous screen.
- 4) Press the [STOP/CANCEL] key to exit the MENU mode.

## Setup menu

Using the Setup menu, you can do the following for setting preferences, etc.

1. Enables or disables the auto level control and limiter functions.
2. Enables or disables the high pass filter.
3. Selects the default recording audio format.
4. Selects the recording source.
5. Turns the phantom power on or off.
6. Selects the monitor mode.
7. Enables or disables the internal speaker.
8. Selects the default file name type.
9. Sets the default file name.
10. Enables or disables the pre record function.
11. Selects the time display mode.
12. Selects the remaining display mode.
13. Sets the maximum file size.
14. Selects the internal battery type.
15. Enables or disables the error tone function.
16. Adjusts the realtime clock.
17. Shows the ROM version.
18. Initializes the Setup menu settings.
19. Upgrades the software.

### Enabling or disabling the auto level control and limiter functions (ALC)

The "ALC" item enables or disables the auto level control and limiter functions. In the following description, it is assumed that the FR-2LE is in the MENU mode and the main menu screen is shown ("File >" is highlighted).

**<Note>**: This menu item can be set in the quick setup mode (see page 55).

- 1) Use the [+] or [-] key to select "Setup >" and press the [MENU/ENTER] key.

The display now shows the Setup menu.

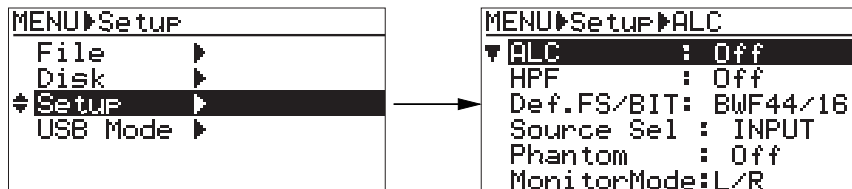

- 2) While "ALC: Off" is highlighted, press the [MENU/ENTER] key.

The current setting (by default, "Off") starts flashing and you can now make setting.

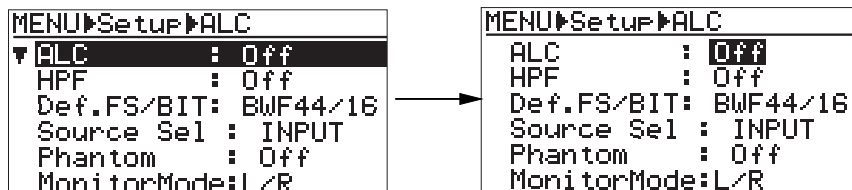

You can select from among the following options.

Off (default)	Neither the ALC (Auto Level Control) nor Limiter function is disabled.
On	The ALC (Auto Level Control) function is enabled.
Limit	The limiter function with the minimum attack and the maximum release time is enabled.

- 3) Use the **[+]** or **[-]** key to select the desired option and press the **[MENU/ENTER]** key. You completes the setting and the display returns to the previous screen.
- 4) Press the **[STOP/CANCEL]** key to exit the MENU mode.

### Enabling or disabling the high pass filter (HPF)

This item enables or disables the high pass filter.

In the following description, it is assumed that the FR-2LE is in the MENU mode and the main menu screen is shown ("File >" is highlighted).

**<Note>**: This menu item can be set in the quick setup mode (see page 55).

- 1) Use the **[+]** or **[-]** key to select "Setup >" and press the **[MENU/ENTER]** key. The display now shows the Setup menu.

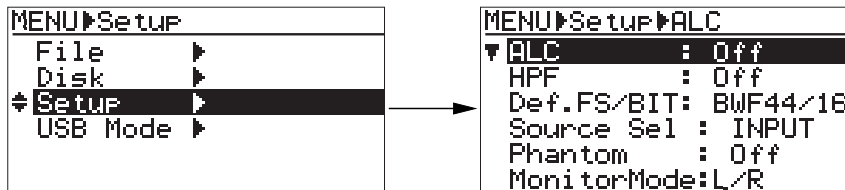

- 2) Use the **[+]** or **[-]** key to select "HPF: \*\*\*\*" and press the **[MENU/ENTER]** key. The current setting (by default, "Off") starts flashing and you can now make setting.

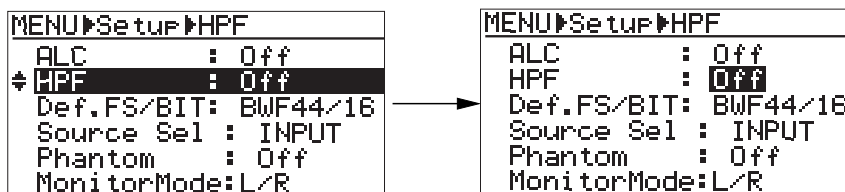

You can select between "Off" and "On".

Off (default)	The high pass filter is disabled.
On	The high pass filter (100 Hz, -12 dB/oct.) is enabled.

- 3) Use the **[+]** or **[-]** key to select "Off" or "On" and press the **[MENU/ENTER]** key. You completes the setting and the display returns to the previous screen.
- 4) Press the **[STOP/CANCEL]** key to exit the MENU mode.

## Selecting the default recording format (Def.FS/BIT)

This item selects the default audio format of a memory card when it is formatted.

In the following description, it is assumed that the FR-2LE is in the MENU mode and the main menu screen is shown ("File >" is highlighted).

**<Note>**: This setting is applied to the audio format setting in the "Format" item on the "Disk" menu. You can, however, change the audio format on the "Format" screen. See page 92 for details.

- 1) Use the [+] or [-] key to select "Setup >" and press the [MENU/ENTER] key.  
The display now shows the Setup menu.

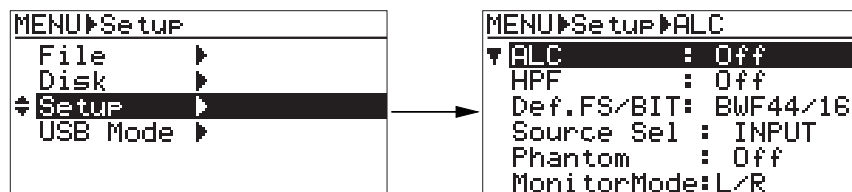

- 2) Use the [+] or [-] key to select "Def. FS/BIT: \*\*\*\*\*" and press the [MENU/ENTER] key.  
The current setting starts flashing and you can now change the setting (in the screen example below, "BWF44/16" is currently selected).

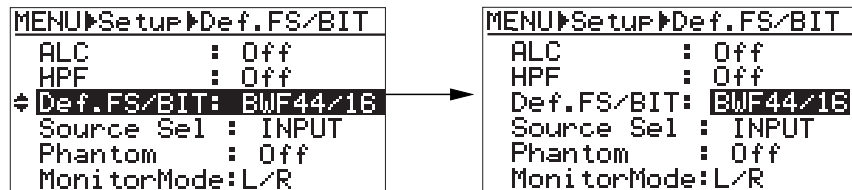

You can select from among the following types, as with the selection on the "Format" screen.

BWF 44/16	44.1kHz/16 bit, BWF file mode
BWF 44/24	44.1kHz/24 bit, BWF file mode
BWF 48/16	48 kHz/16 bit, BWF file mode
BWF 48/24	48 kHz/24 bit, BWF file mode
BWF 88/24	88.2 kHz/24 bit, BWF file mode
BWF 96/24	96 kHz/24 bit, BWF file mode
MP3-192	MP3 192kbps compressed file mode

\* MP3 (MPEG Layer-3): The MPEG Layer-3 audio decoding technology is licensed from Fraunhofer IIS and Thomson.

- 3) Use the [+] or [-] key to select the desired format and press the [MENU/ENTER] key.  
You completes the setting and the display changes to show the previous screen.
- 4) Press the [STOP/CANCEL] key to exit the MENU mode.

## Selecting the recording sources (Source Sel)

This item selects the recording sources between the internal microphones and external sources. In the following description, it is assumed that the FR-2LE is in the MENU mode and the main menu screen is shown ("File >" is highlighted).

**<Note>**: This menu item can be set in the quick setup mode (see page 55).

- 1) Use the [+] or [-] key to select "Setup >" and press the [MENU/ENTER] key. The display now shows the Setup menu.

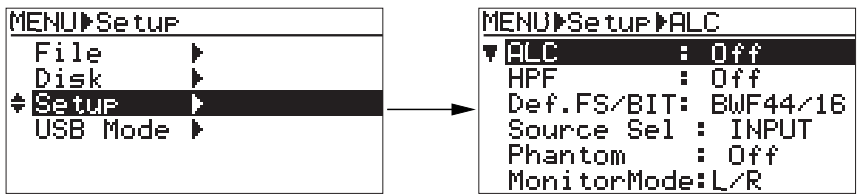

- 2) Use the [+] or [-] key to select "Source Sel" and press the [MENU/ENTER] key. The current setting starts flashing and you can now change the setting (by default, "INPUT" is selected).

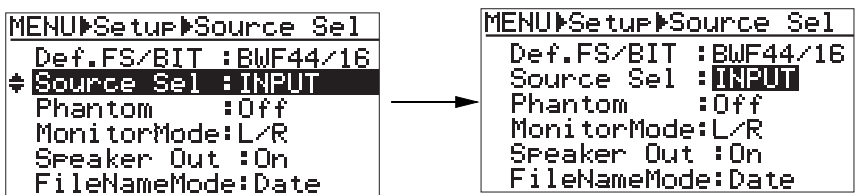

You can select from among the following options.

INPUT (default)	External sound sources (microphones or line level signals) fed to the [ANALOG IN] connectors are selected. The internal microphones are disabled.
I. MIC H	The internal microphones are selected. The sensitivity is high (32 dB). The [ANALOG IN] connectors are disabled.
I. MIC L	The internal microphones are selected. The sensitivity is low (16 dB). The [ANALOG IN] connectors are disabled.

**<Note>**: When you select "I. MIC H" or "I. MIC L", the MIC TRIM and recording level controls are ineffective.

- 3) Use the [+] or [-] key to select the desired sources and press the [MENU/ENTER] key. You completes the setting and the display changes to show the previous screen.
- 4) Press the [STOP/CANCEL] key to exit the MENU mode.

## Turning the phantom power on or off (Phantom)

When you use a microphone which requires the phantom power, use this menu item to turn the phantom power on.

In the following description, it is assumed that the FR-2LE is in the MENU mode and the main menu screen is shown ("File >" is highlighted).

**<Note>**: This menu item can be set in the quick setup mode (see page 55).

### <Notes on using the phantom power>

- The phantom power is supplied only to the [ANALOG IN] XLR connectors.
- When you use a condenser microphone, make sure that it can be used with the phantom power.
- Turn on the phantom power after you connect the microphone(s) to the [ANALOG IN] connector(s).
- When you turn on or off the phantom power or when you plug or unplug a microphone to or from the [ANALOG IN] connector, turn down the recording level or [MONITOR] level controls.

- 1) Use the [+] or [-] key to select "Setup >" and press the [MENU/ENTER] key. The display now shows the Setup menu.

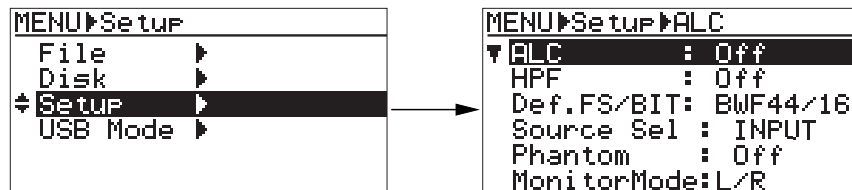

- 2) Use the [+] or [-] key to select "Phantom >" and press the [MENU/ENTER] key. The current setting starts flashing and you can now change the setting (by default, "Off" is selected).

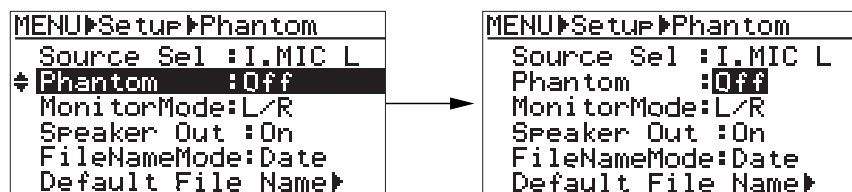

You can select either of the following options.

Off (default)	The phantom power is not supplied.
On	The phantom power is supplied to the [ANALOG IN] XLR connectors.

**<Note>**: The phantom power setting is effective both to the left and right channels.

- 3) Use the [+] or [-] key to select "On" or "Off" and press the [MENU/ENTER] key. You completes the setting and the display changes to show the previous screen.
- 4) Press the [STOP/CANCEL] key to exit the MENU mode.

## Selecting the monitor mode (Monitor Mode)

This item selects whether the unit outputs signals from the [MONITOR OUT] connectors, [PHONES] jack and internal speaker in stereo or mono.

In the following description, it is assumed that the FR-2LE is in the MENU mode and the main menu screen is shown ("File >" is highlighted).

**<Note>**: When a plug is inserted to the [PHONES] jack, the internal speaker is disabled.

- 1) Use the [+] or [-] key to select "Setup >" and press the [MENU/ENTER] key. The display now shows the Setup menu.

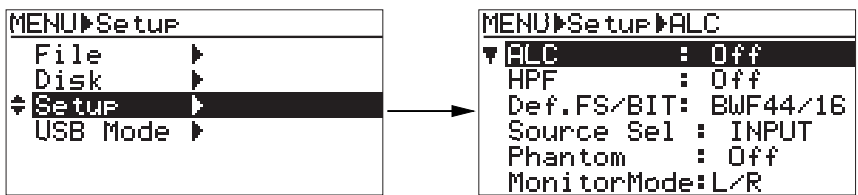

- 2) Use the [+] or [-] key to select "Monitor Mode:\*\*\*" and press the [MENU/ENTER] key. The current setting starts flashing and you can now change the setting (by default, "L/R" is selected).

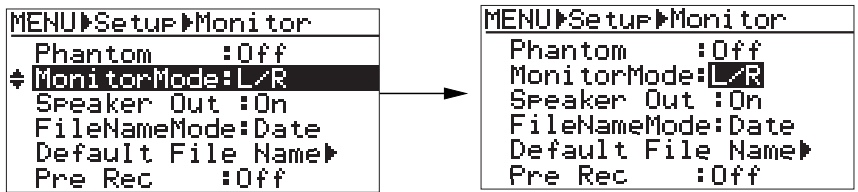

You can select either of the following options.

L/R (default)	Signals are output in stereo.
MONO	Signals are output in mono.

- 3) Use the [+] or [-] key to select the desired option and press the [MENU/ENTER] key. You completes the setting and the display changes to show the previous screen.
- 4) Press the [STOP/CANCEL] key to exit the MENU mode.



## Enabling or disabling the internal speaker (Speaker Out)

This item selects whether enabling or disabling the internal speaker during playback. By default, it is enabled so you can hear the monitor sound from the internal speaker.

In the following description, it is assumed that the FR-2LE is in the MENU mode and the main menu screen is shown ("File >" is highlighted).

**<Note>**: Even though "On" is selected, inserting a headphone plug to the [PHONES] jack disables the internal speaker. Also note that the internal speaker is disabled during recording or record standby.

- 1) Use the [+] or [-] key to select "Setup >" and press the [MENU/ENTER] key.  
The display now shows the Setup menu.

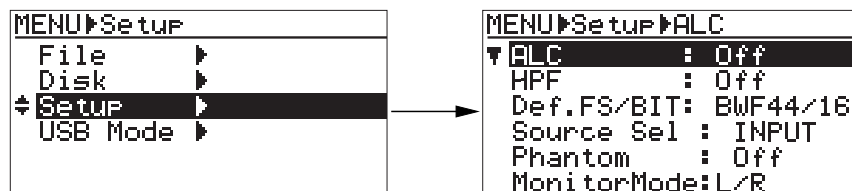

- 2) Use the [+] or [-] key to select "Speaker Out" and press the [MENU/ENTER] key.  
The current setting starts flashing and you can now change the setting (by default, "On" is selected).

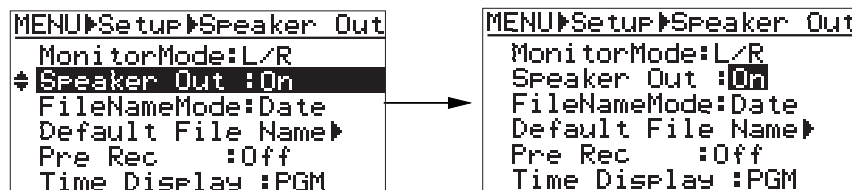

You can select either of the following options.

On (default)	The internal speaker is enabled during playback.
Off	The internal speaker is disabled during playback.

- 3) Use the [+] or [-] key to select "On" or "Off" and press the [MENU/ENTER] key.  
You completes the setting and the display changes to show the previous screen.
- 4) Press the [STOP/CANCEL] key to exit the MENU mode.

## Selecting the default file name type (File Name Mode)

Each time recording is made, an audio file is created with a specific "default" file name which is automatically given.

This menu item selects the default file name type from among the creation date/time, "scene name + take number" and "reel number + File number".

In the following description, it is assumed that the FR-2LE is in the MENU mode and the main menu screen is shown ("File >" is highlighted).

- 1) Use the [+] or [-] key to select "Setup >" and press the [MENU/ENTER] key.

The display now shows the Setup menu.

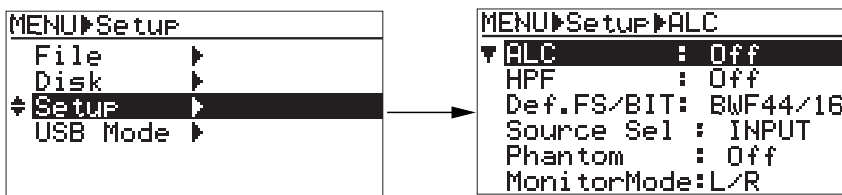

- 2) Use the [+] or [-] key to select "FileNameMode: \*\*" and press the [MENU/ENTER] key.

The current setting starts flashing and you can now change the setting (by default, "Date" is selected).

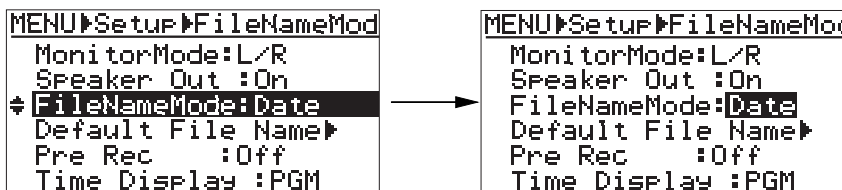

You can select from among the following options.

Date (default)	A file name contains date/time information of the realtime clock when the audio file is created. For example, if a file is created at 12:30:25 on January 25 in 2007, the file name is "B12h30m25s25jan2007y.wav" (for a BWF file) or "B12h30m25s25jan2007y.mp3" (for a mp3 file) (up to 15 characters are shown on the display).
Take	A file name contains the desired scene name which is set by the "Default Scene Name" item and take number. For example, if you set the scene name to "Original Name" and take number is "001", the file name is "Original Name_001.wav" (for a BWF file) or "Original Name_001.mp3" (for a mp3 file).
Reel	A file name contains the volume label (Reel number) of the CompactFlash card and the file number. For example, if you set the reel number to "*****" and the file number is "001", the file name is "*****_001.wav" (for a BWF file) or "*****_001.mp3" (for a mp3 file).

- 3) Use the [+] or [-] key to select the desired option and press the [MENU/ENTER] key.

If you select "Date" or "Reel", the display returns to the previous screen, so go to step 4) to quit the MENU mode.

If you select "Take", the display automatically shows the screen for setting the "Default File Name" item, so set the default file name (see "Setting the default file name" on the next page).

- 4) Press the [STOP/CANCEL] key to exit the MENU mode.

## Setting the default file name (Default File Name)

This item sets the scene name and take number which are used in a file name when the file name mode is set to "Take" (see the previous page).

In the following description, it is assumed that the FR-2LE is in the MENU mode and the main menu screen is shown ("File >" is highlighted).

- 1) Use the [+] or [-] key to select "Setup >" and press the [MENU/ENTER] key.  
The display now shows the Setup menu.

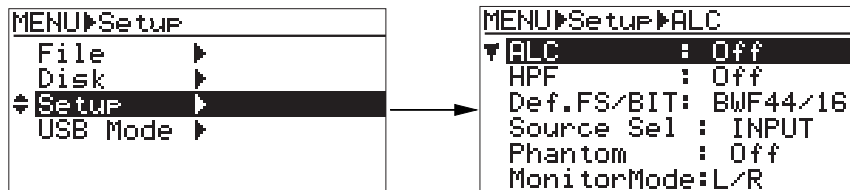

- 2) Use the [+] or [-] key to select "Default File Name" and press the [MENU/ENTER] key.  
The display now shows the screen for selecting a default file name. The top row ("\* 01:Scene01\_001" on the screen above) shows the currently selected default "scene name + take number".

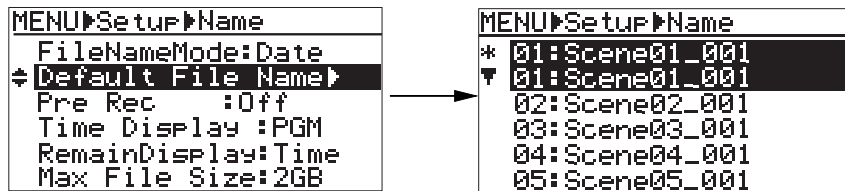

- 3) Use the [+] or [-] key to select the desired scene name and press the [MENU/ENTER] key.  
On the screen below, "02:Scene02\_001" is selected.

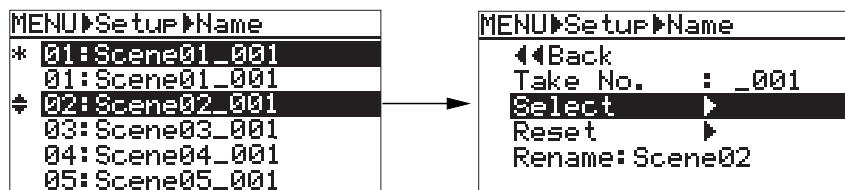

The function of each parameter is as below.

Take No.	Selects the take number (001 through 999).
Select	Sets the edited "scene name + take number" to the default file name.
Reset	Resets the default file name to the default (such as Scene01_001).
Rename	Renames a scene name.

The description from the next page shows the procedure example of setting the default file name: selecting "02: Scene02\_001", then editing the scene name and take number, and finally making the edited scene name and take number effective.

**• Selecting the take number**

- 1) Use the [+] or [-] key to select "Take No.:\*\*\*" and press the [MENU/ENTER] key. The take number currently set starts flashing (by default, "001").

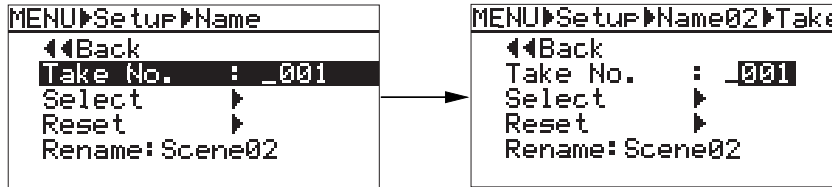

- 2) Use the [+] or [-] key to select the desired take number and press the [MENU/ENTER] key. You can set the take number between 001 and 999. By pressing the [MENU/ENTER] key, the selected take number is set and the display returns to the previous screen. (In the procedure example here, we go to the next step without changing the take number from 001.)

**• Renaming the scene name**

- 1) Use the [+] or [-] key to select "Rename >" and press the [MENU/ENTER] key. The display now shows the editing screen as below, on which you can rename the scene name (Scene02).

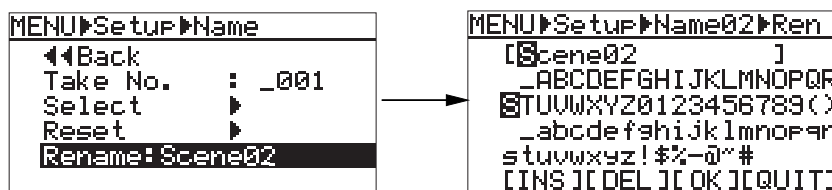

The cursor in [ ] is called "scene name cursor", while the cursor in the character options is called "character selection cursor".

- 2) Enter the desired scene name. See below for details about how to edit a scene name. The maximum length of a file name string is 13 characters.

To move the scene name cursor	Use the [REWIND] or [F FWD] key.
To move the character selection cursor	Use the [+] or [-] key.
To edit a character at the scene name cursor position	Use the [+] or [-] key to move the character selection cursor to the desired character.
To insert a space	You can insert a space at the right of the scene name cursor. Move the scene name cursor to the desired position, move the character selection cursor to "[INS]", and press the [MENU/ENTER] key.
To insert a character	You can insert a character at the left of the scene name cursor. Move the scene name cursor to the desired position, move the character selection cursor to "[INS]", and press the [MENU/ENTER] key. Then move the character selection cursor to a desired character and press the [MENU/ENTER] key.
To delete a character	Move the scene name cursor to the character you want to delete, move the character selection cursor to "[DEL]", and press the [MENU/ENTER] key.

- 3) After you complete editing, press the [MENU/ENTER] key.

The renamed scene name is confirmed and the display returns to the previous screen (In the example below, "Original Name" is set).

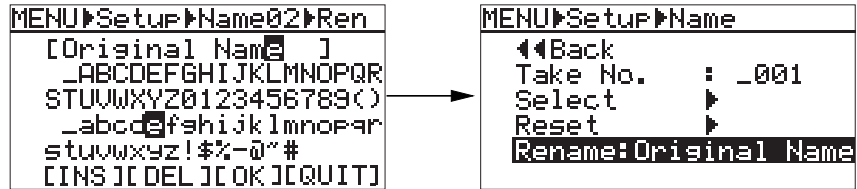

• Making the edited file name (scene name + take number) effective

- 1) Use the [+] or [-] key to select "Select >" and press the [MENU/ENTER] key.

The edited file name (scene name and take number) is now set to the default file name. The display changes to show the screen as below right (in this example, "Original Name\_001" is set).

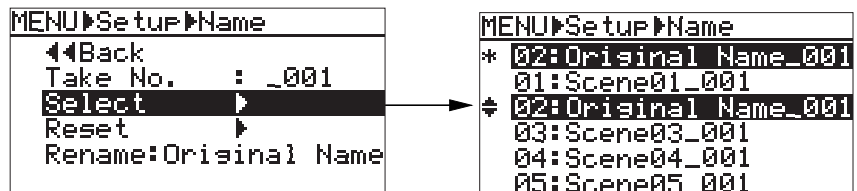

- 2) Press the [STOP/CANCEL] key to exit the MENU mode.

As described above, if you set the default file name whose scene name is "Original Name" and whose take number is "001", the name of the first file is "Original Name\_001". If you make another recording in this condition, the name of the next file will be "Original Name\_002". The take number is counted up each time recording is made.

• Resetting a default file name

- 1) Select the file name you want to reset, and press the [MENU/ENTER] key.

In the screen example below, "Original Name\_001" is selected.

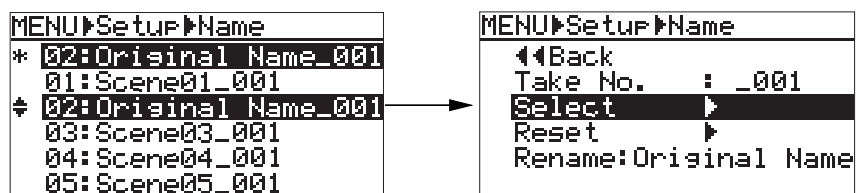

- 2) Use the [+] or [-] key to select "Reset >" and press the [MENU/ENTER] key.

The selected file name is reset to the initial name.

In the case of "Original Name\_001" above, it is reset to "Scene02\_001".

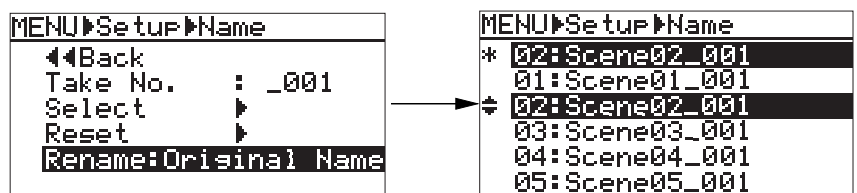

- 3) Press the [STOP/CANCEL] key to exit the MENU mode.

## Enabling or disabling the pre record function (Pre Rec)

This item enables or disable the pre record function (by default, it is disabled). When the pre record function is enabled, recording starts with 2 seconds of audio data stored in the buffer. This prevents missing the start of important recording.

In the following description, it is assumed that the FR-2LE is in the MENU mode and the main menu screen is shown ("File >" is highlighted).

- 1) Use the [+] or [-] key to select "Setup >" and press the [MENU/ENTER] key. The display now shows the Setup menu.

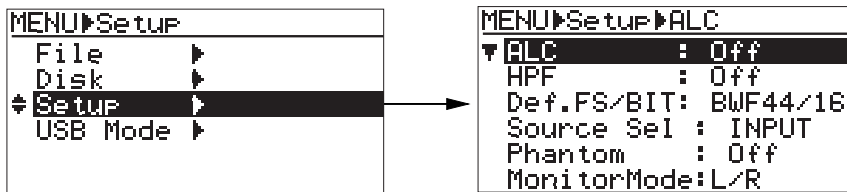

- 2) Use the [+] or [-] key to select "Pre Rec:\*\*\*" and press the [MENU/ENTER] key. The current setting starts flashing and you can now change the setting (by default, "Off" is selected).

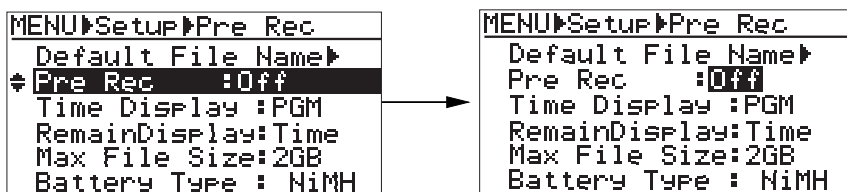

You can select either of the following options.

On	The unit starts recording from the data captured in the buffer. In other words, you can actually start recording two seconds earlier than you press the [RECORD] key.
Off (default)	The unit starts recording of the current (realtime) data. The data captured in the buffer is not recorded.

- 3) Use the [+] or [-] key to select "On" or "Off" and press the [MENU/ENTER] key. You completes the setting and the display changes to show the previous screen.
- 4) Press the [STOP/CANCEL] key to exit the MENU mode.

## Selecting the time display mode (Time Display)

This item selects the time display mode of the time counter on the display from among ABS, program time and time stamp (24H). The default is ABS.

This counter shows the current position of the file in ABS time, PRG or 24H (Time Stamp). The time display mode can be set by the "Time Display" menu item on the "Setup" menu in the MENU mode (the default time display mode is "ABS").

In the following description, it is assumed that the FR-2LE is in the MENU mode and the main menu screen is shown ("File >" is highlighted).

- 1) Use the [+] or [-] key to select "Setup >" and press the [MENU/ENTER] key.

The display now shows the Setup menu.

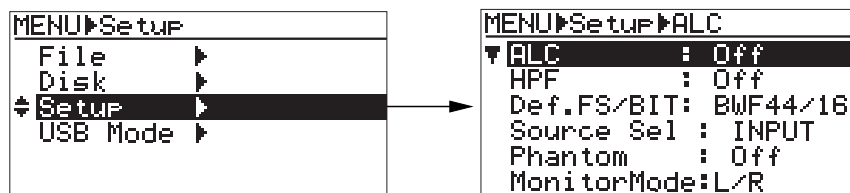

- 2) Use the [+] or [-] key to select "Time Display: \*\*\*" and press the [MENU/ENTER] key.

The current setting starts flashing and you can now change the setting (by default, "ABS" is selected).

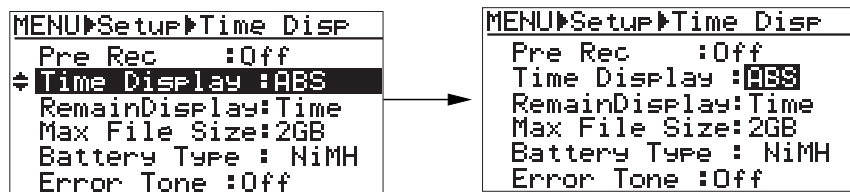

You can select from among the following options.

ABS (default)	The time counter starts from the beginning of the first audio file which is set to zero (ABS 0) and indicates the elapsed time from "ABS 0". Time is counted continuously throughout all audio files.
PGM	For each audio file, the time counter starts from zero.
24H	The time counter shows the BWF time stamp value which records the internal realtime counter.

- 3) Use the [+] or [-] key to select the desired option and press the [MENU/ENTER] key.  
The selected time display mode is set and the display returns to the previous screen.
- 4) Press the [STOP/CANCEL] key to exit the MENU mode.

## Selecting the remaining display mode (Remain Display)

This item selects whether the remaining card space is displayed in time or Mbytes.

In the following description, it is assumed that the FR-2LE is in the MENU mode and the main menu screen is shown ("File >" is highlighted).

- 1) Use the [+] or [-] key to select "Setup >" and press the [MENU/ENTER] key.

The display now shows the Setup menu.

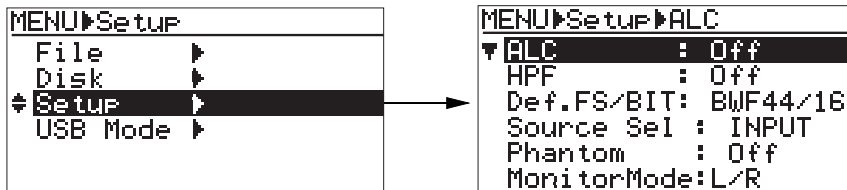

- 2) Use the [+] or [-] key to select "Remain Display:\*\*\*" and press the [MENU/ENTER] key.

The current setting starts flashing and you can now change the setting (by default, "Time" is selected).

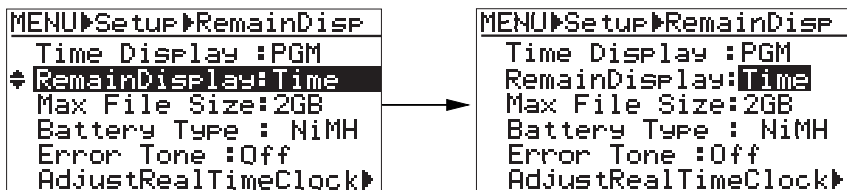

You can select between the following options.

MByte	The remaining space of the memory card is displayed in Mbytes.
Time (default)	The remaining space of the memory card is displayed in time.

- 3) Use the [+] or [-] key to select the desired option and press the [MENU/ENTER] key. The selected mode is set and the display returns to the previous screen.
- 4) Press the [STOP/CANCEL] key to exit the MENU mode.

**<Note>**: For details about the remaining display, see page 45 in "Chapter 3: Names and functions".

The following shows the screen examples of both remaining display modes.

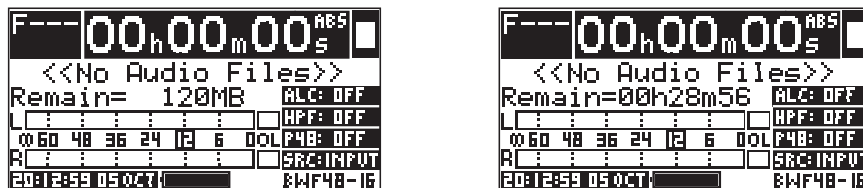

<Remaining display mode is "MByte">

<Remaining display mode is "Time">



## Setting the maximum file size (Max File Size)

This item selects the maximum audio file size between 2 GB and 4 GB (the default is 2 GB).

In the following description, it is assumed that the FR-2LE is in the MENU mode and the main menu screen is shown ("File >" is highlighted).

**<Note>**: During recording, the recorder automatically quits recording and stops if the file size reaches the maximum file size. Note that if you use a memory card whose size is less than the maximum file size, the recorder stops recording at the point when there is no more recording space left.

- 1) Use the [+] or [-] key to select "Setup >" and press the [MENU/ENTER] key.  
The display now shows the Setup menu.

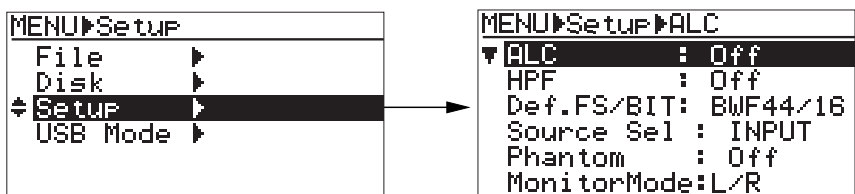

- 2) Use the [+] or [-] key to select "Max File Size" and press the [MENU/ENTER] key.  
The current setting starts flashing and you can now change the setting (by default, "2GB" is selected).

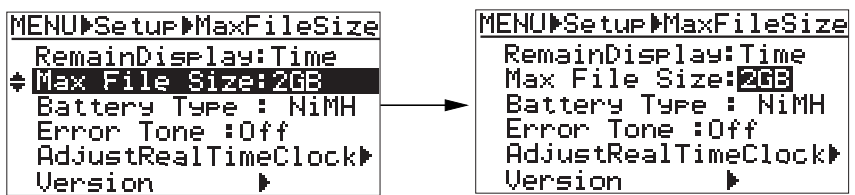

You can select between the following options.

2GB (default)	The maximum file size is 2 GB.
4GB	The maximum file size is 4 GB.

- 3) Use the [+] or [-] key to select the desired option and press the [MENU/ENTER] key.  
The selected file size is set and the display returns to the previous screen.
- 4) Press the [STOP/CANCEL] key to exit the MENU mode.

## Selecting the internal battery type (Battery Type)

This item selects the battery type when you operate the unit with batteries (Ni-MH, Ni-Cd, alkaline or Tamiya).

In the following description, it is assumed that the FR-2LE is in the MENU mode and the main menu screen is shown ("File >" is highlighted).

**<Note>**: When you operate the unit on AA-type batteries, set this item correctly. Otherwise, Some functions such as the error tone output function may not correctly work.

**<Note>**: When you set the Tamiya battery to the unit, the unit automatically detects it and sets the "Battery Type" item to "RC7.2V". When you replace the Tamiya battery with size AA batteries (alkaline, Ni-Cd, or Ni-MH), set the "Battery Type" item manually to the appropriate option. If you use size AA batteries while the "Battery Type" item is set to "RC7.2V", the unit generates the alarm to minimize damaging the batteries. To stop the alarm, set the "Battery Type" item appropriately.

- 1) Use the [+] or [-] key to select "Setup >" and press the [MENU/ENTER] key.

The display now shows the Setup menu.

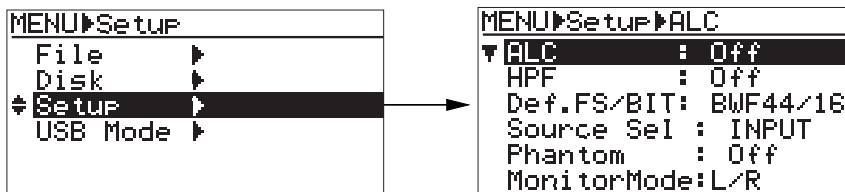

- 2) Use the [+] or [-] key to select "Max File Size" and press the [MENU/ENTER] key.

The current setting starts flashing and you can now change the setting (by default, "NiMH" is selected).

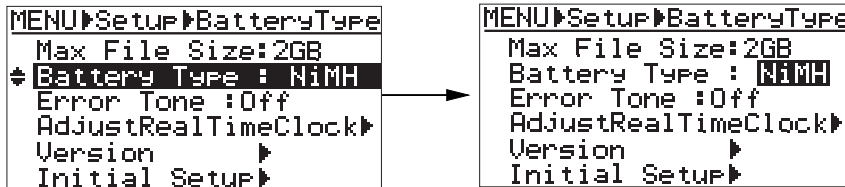

You can select from among the following options.

NiMH (default)	Select this option when you use Ni-MH (Nickel Metal Hydride) batteries.
NiCd	Select this option when you use Ni-Cd (nickel cadmium) batteries.
Alkali	Select this option when you use alkaline batteries.
RC7.2V	Select this option when you use the Tamiya battery. When you set the Tamiya battery to the unit, the unit automatically detects it and sets the "Battery Type" item to "RC7.2V".

- 3) Use the [+] or [-] key to select the desired option and press the [MENU/ENTER] key.  
The selected battery type is set and the display returns to the previous screen.
- 4) Press the [STOP/CANCEL] key to exit the MENU mode.

## Enabling or disabling the error tone function (Error Tone)

This menu item selects whether or not outputting the error tone.

The error tone can be output when battery voltage becomes low or the remaining space of the memory card becomes less than one minute (see the bottom of this page for details).

In the following description, it is assumed that the FR-2LE is in the MENU mode and the main menu screen is shown ("File >" is highlighted).

- 1) Use the [+] or [-] key to select "Setup >" and press the [MENU/ENTER] key.  
The display now shows the Setup menu.

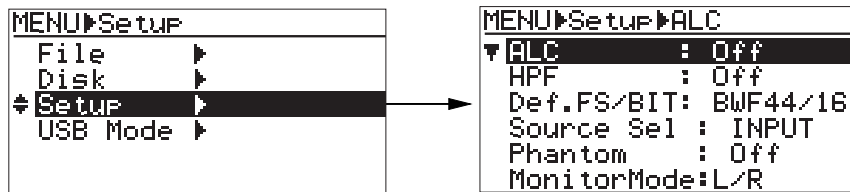

- 2) Use the [+] or [-] key to select "Error Tone: \*\*\*" and press the [MENU/ENTER] key.  
The current setting starts flashing and you can now change the setting (by default, "Off" is selected).

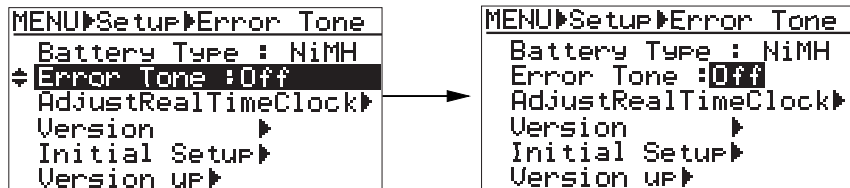

You can select either of the following options.

Off (default)	The error tone cannot be output.
On	The error tone can be output.

- 3) Use the [+] or [-] key to select "On" or "Off" and press the [MENU/ENTER] key.  
You completes the setting and the display changes to show the previous screen.
- 4) Press the [STOP/CANCEL] key to exit the MENU mode.

The error tone is output in any of the following conditions:

Condition	Error tone type
When the battery voltage lowers the certain level.	— — — —
When the remaining time of the memory card gets less than one minute during recording or record standby.	— — — —

## Adjusting the real time clock (Adjust Real Time)

This menu item sets the internal realtime clock. When the FR-2LE is shipped, the realtime clock is adjusted to the local standard time. You can adjust the clock to your standard time by the following procedure. Time data can be used for the file name or file creation date of an audio file, time stamp of a BWF file, etc.

In the following description, it is assumed that the FR-2LE is in the MENU mode and the main menu screen is shown ("File >" is highlighted).

- 1) Use the [+] or [-] key to select "Setup >" and press the [MENU/ENTER] key.  
The display now shows the Setup menu.

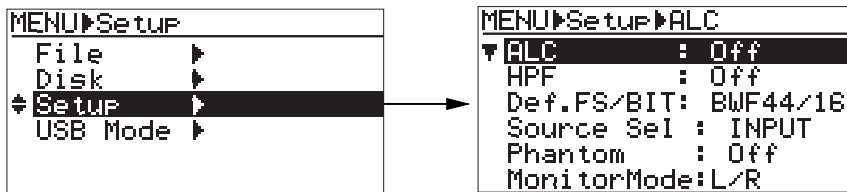

- 2) Use the [+] or [-] key to select "AdjustRealTimeClock >" and press the [MENU/ENTER] key.  
The display now shows the screen on which the realtime clock is running.

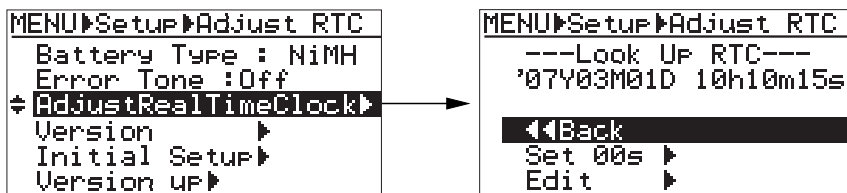

By selecting "Set 00s >" and pressing the [MENU/ENTER] key while the realtime clock is running, you can reset the second field to "00". When the current value on the second field is 29 or less, simply the second field is reset to "00". When the current value on the second field is 30 or more, the minute field is counted up and the second field is reset to "00".

- 3) Use the [+] or [-] key to select "Edit >" at the bottom on the screen and press the [MENU/ENTER] key.

The time data currently displayed is hold and you can edit it.  
You can select the field you edit by using the [REWIND] or [F FWD] key.

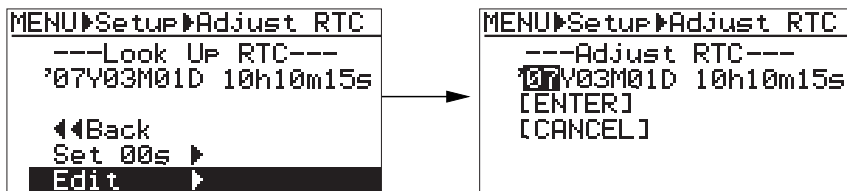

- 4) Edit the time data.  
By pressing the [MENU/ENTER] key after editing a value at the current cursor position, the cursor automatically moves to the next field. (If you do not want to change the value at the current position, simply press the [MENU/ENTER] key to move the cursor right.)  
By pressing the [MENU/ENTER] key after editing a value in the second field, the cursor moves to "[ENTER]". When the cursor is at a position other than the second field, you can move the cursor to "[ENTER]" by pressing the [MENU/ENTER] key or [F FWD] key repeatedly.

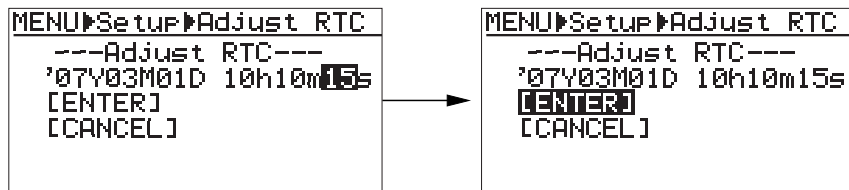

- 5) **After entering a desired time value, press the [MENU/ENTER] key.**  
 The entered time data is set and the display returns to the previous screen.  
 You can set the realtime clock precisely by pressing the [MENU/ENTER] key in sync with the time signal.

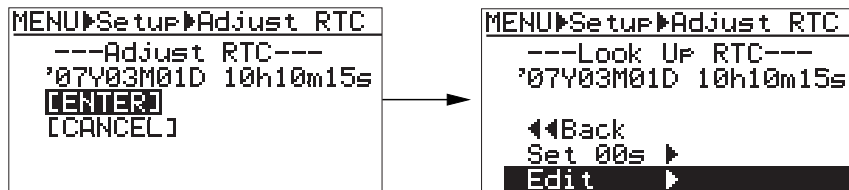

- 6) **Press the [STOP/CANCEL] key to exit the MENU mode.**

## Showing the ROM version (Version)

This item is used for showing the ROM version of the unit.

In the following description, it is assumed that the FR-2LE is in the MENU mode and the main menu screen is shown ("File >" is highlighted).

**<Note>**: The software of the FR-2LE may be updated in the future.  
 To get the information about the latest software version, visit the Fostex web site (<http://www.fostexinternational.com>) or ask your local Fostex dealer or service station.

- 1) **Use the [+] or [-] key to select "Setup >" and press the [MENU/ENTER] key.**  
 The display now shows the Setup menu.

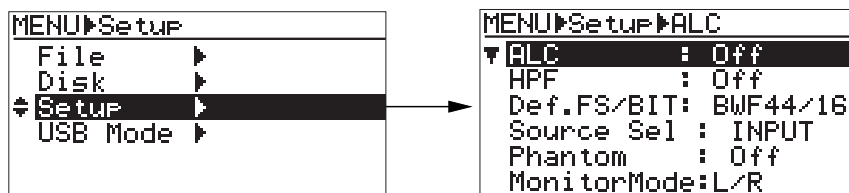

- 2) **Use the [+] or [-] key to select "Version >" and press the [MENU/ENTER] key.**  
 The current version number and creation date of the ROM installed to the unit is displayed.

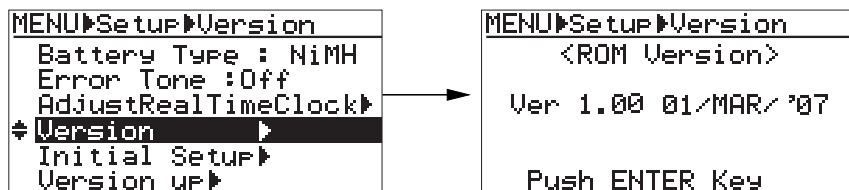

- 3) **To dismiss the ROM version screen, press the [MENU/ENTER] key.**  
 4) **Press the [STOP/CANCEL] key to exit the MENU mode.**

## Initializing the Setup menu settings (Initial Setup)

This menu item is used for initializing all settings of the Setup menu to the factory-preset condition. In the following description, it is assumed that the FR-2LE is in the MENU mode and the main menu screen is shown ("File >" is highlighted).

ALC	Off	
HPF	Off	
Def. FS/BIT	BWF 44/16	
Source Sel	INPUT	
Phantom	Off	
File Name Mode	Date	
Default Scene Name	Scene Name	Scene01 - Scene20
	Take Number	001
Error Tone	Off	
Pre Rec	Off	
Remain Display	Time	
Battery Type	Ni-MH	
Max. File Size	2GB	
Time Display	ABS	
Monitor Mode	L/R	
Speaker Out	On	

\* In addition to the above items, the contrast is also reset to the initial condition.

- 1) Use the [+] or [-] key to select "Setup >" and press the [MENU/ENTER] key. The display now shows the Setup menu.

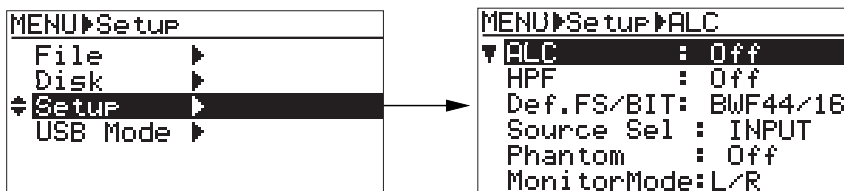

- 2) Use the [+] or [-] key to select "Initial Setup >" and press the [MENU/ENTER] key. The display now shows the Initial Setup screen where "Are You Sure?" flashes.

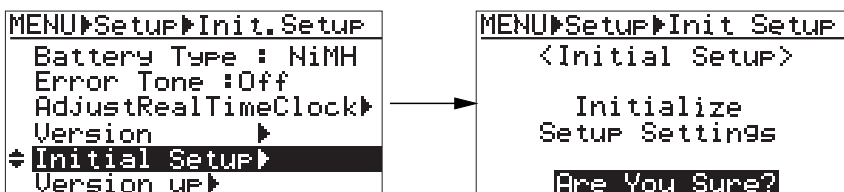

- 3) Press the [MENU/ENTER] key to initialize the Setup menu. The unit starts initializing the Setup menu. When completed, "Completed!" is shown.

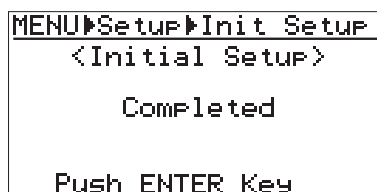

- 4) Press the [MENU/ENTER] key, followed by the [STOP/CANCEL] key to exit the MENU mode.

## Upgrading the software (Version up)

You can upgrade the software of the unit via this menu item.

In the following description, it is assumed that the latest software has been downloaded from the Fostex web site (or supplied by Fostex dealer or service station) and copied to the memory card which is currently set to the FR-2LE, while the FR-2LE is in the MENU mode and the main menu screen is shown ("File >" is highlighted).

**<Note>**: For details about how to copy the software downloaded from the Fostex web site (<http://www.fostexinternational.com>) to the FR-2LE memory card, see "Copying a file from a PC to a memory card" on page 72.

- 1) Use the [+] or [-] key to select "Setup >" and press the [MENU/ENTER] key.

The display now shows the Setup menu.

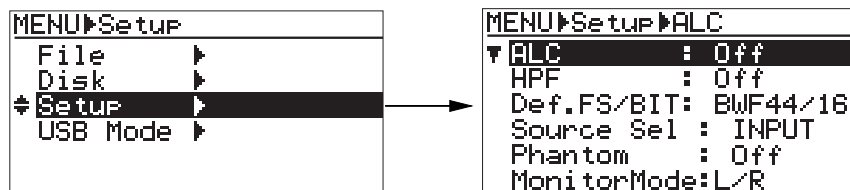

- 2) Use the [+] or [-] key to select "Version up >" and press the [MENU/ENTER] key.

The display now shows the software number on the memory card (for example, "FR2LV100.MOT").

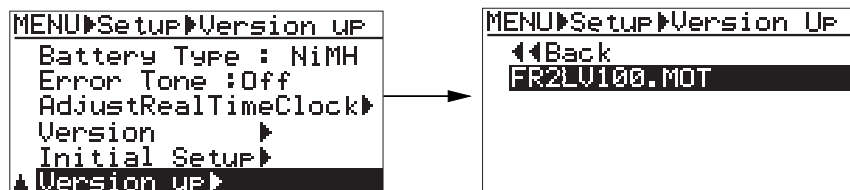

- 3) Press the [MENU/ENTER] key.

The display now shows the Version up screen where "Are you sure?" flashes.

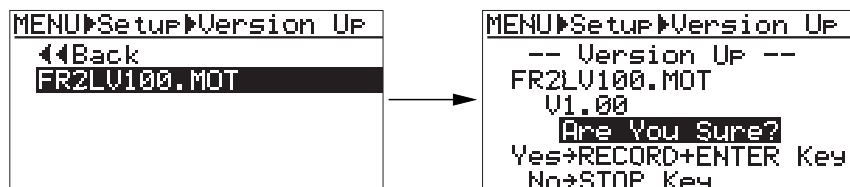

- 4) Press the [MENU/ENTER] key while holding down the [RECORD] key.

The unit starts writing the software. When completed, "Completed!" is shown.

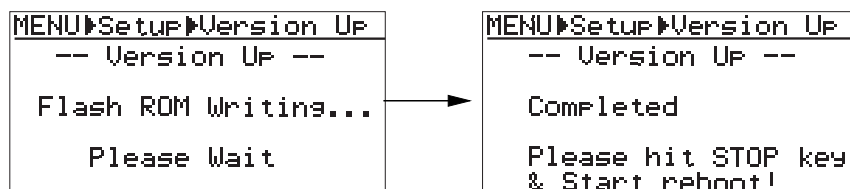

- 5) Press the [STOP/CANCEL] key to exit the MENU mode.

The display returns to show the Home screen which was shown before entering the MENU mode.

- 6) Turn off the FR-2LE power and then on again.

You need to turn off the power and then on again after upgrading the version.

To check that the version has been upgraded, follow the procedure described on page 109.





# Chapter 8: Main specifications

## Inputs/Outputs

\*0 dBu=0.775 Vrms, 0 dBV=1 Vrms.

### ANALOG IN [L, R]

Connectors	: XLR-Phone Combo type
<LINE input>	
Connectors	: $\varnothing$ 6mm TS phone jack (unbalanced)
Input impedance	: More than 10k $\Omega$
Nominal input level	: -10 dBV
Maximum input level	: +2 dBV
<MIC input>	
Connectors	: XLR-3-31 type (balanced, pin 2= HOT)
Input impedance	: More than 6k $\Omega$
Nominal input level	: -50 dBu to -10 dBu
Maximum input level	: +2 dBu
Phantom power	: 48 V

### MONITOR OUT [L, R]

Connectors	: RCA type (unbalanced)
Applicable load impedance	: More than 10k $\Omega$
Nominal output level	: -10 dBV

### PHONES

Connector	: Stereo mini-phone jack
Applicable load impedance	: More than 32 $\Omega$
Maximum output power	: 15 mW + 15 mW (32 $\Omega$ load)

### USB 2.0 (for PC connection)

Connector	: Series "B" Receptacle
Pin assignment	: 1= VBUS, 2= D-, 3= D+, 4= GND

### Internal speaker

Maximum output level	: 300mW
----------------------	---------

## Recording/playback

Recording medium	: CompactFlash™ card
Recording Format	: BWF (Broadcast Wave Format) : MP3 (MPEG Layer-3)

\* MPEG Layer-3 audio coding technology licensed from Fraunhofer IIS and Thomson.

**Quantization and Sampling Frequency**

- : 16-bit at 44.1kHz/48kHz
- : 24-bit at 44.1kHz/48kHz/88.2kHz/96kHz
- : MP3-192kbps

**Recording tracks** : stereo

**Record/Playback frequency response**

- : 20Hz to 20kHz, +/-2 dB (at 44.1kHz/48kHz FS)
- : 20Hz to 40kHz, +/-3 dB (at 88.2kHz/96kHz FS)

**Signal to Noise Ratio** (between ADC and DAC, 24-bit,, 48 kHz FS)

- Line : 95dB (typical)
- Mic (MIC TRIM max.) : 85dB (typical)

**Dynamic Range** (between ADC and DAC, 24-bit, 48 kHz FS)

- : 95dB (typical)

**T.H.D.** (between ADC and DAC, 24-bit, 48 kHz FS)

- Line : Less than 0.008% (at 1 kHz, -1 dB typical)
- Mic (MIC TRIM max.) : Less than 0.01% (at 1 kHz, -1 dB typical)

**Channel Separation** (24-bit, 48 kHz FS)

- : 90dB or more at 1kHz, 0dB (24bit, Fs 48kHz)

**Reference Level** : -12dBFS

**Locate memory** : 99 cue points per file can be stored.

**General**

**Dimensions** : 57 (H) x 206 (W) x 132 (D) mm

**Weight** : Approximately 800g (excluding batteries)

**Power supply** : DC12V  
: AC adaptor (supplied)   
: four size AA (alkaline, Ni-Cd, Ni-MH) batteries (not supplied)  
: Tamiya battery(not supplied)

**Power consumption** : approximately 3W

\* Specifications and appearance are subject to change without notice for product improvement.

\* For details about the supplied accessories, see page 17.

Physical dimensions

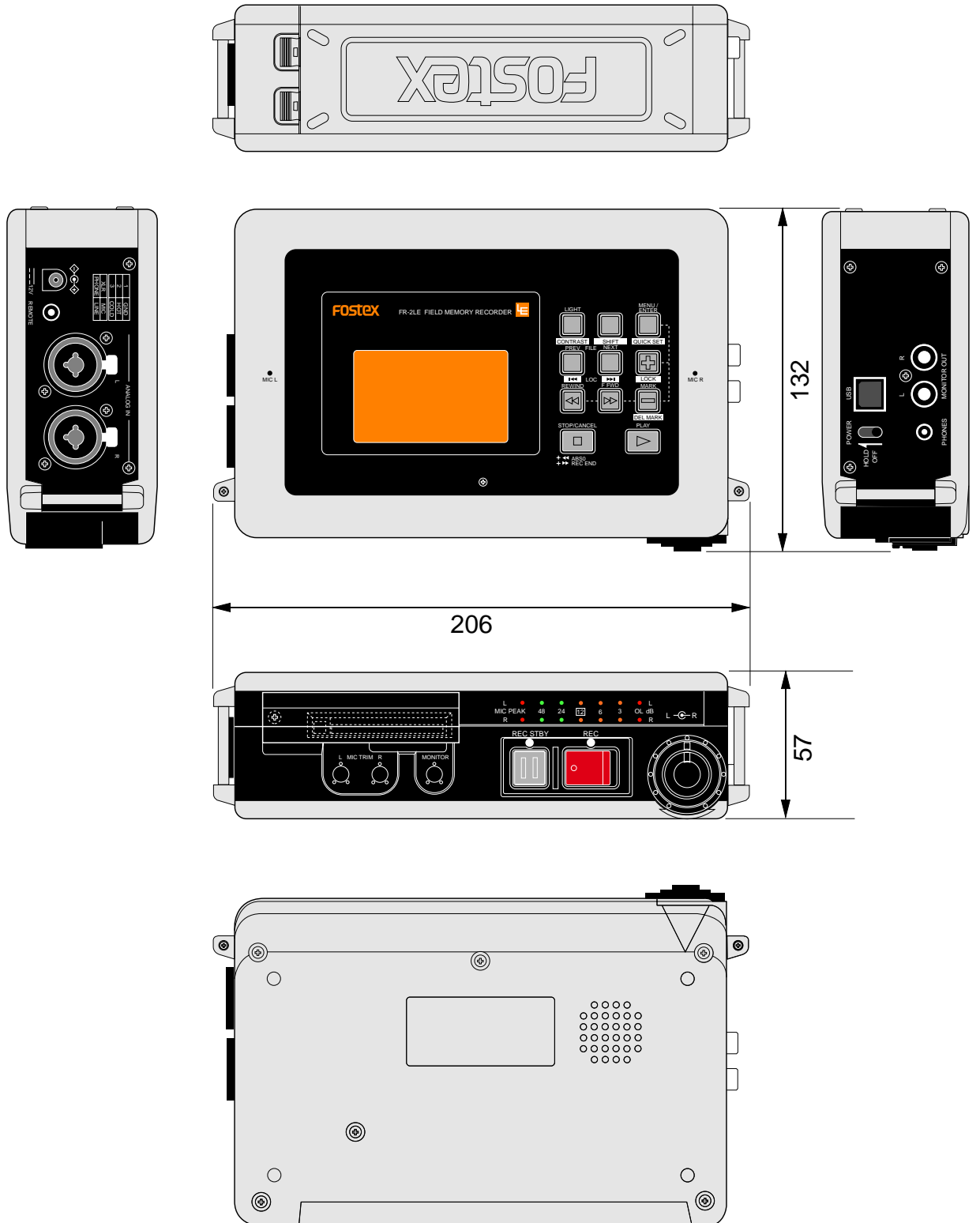

## Declaration of EC Directive

This equipment is compatible with the EMC Directive (89/336/EEC) - Directive on approximation of member nation's ordinance concerning the electromagnetic compatibility and with the Low Voltage Directive (73/23/EEC) - Directive on approximation of member nation's ordinance concerning electric equipment designed to be used within the specified voltage range.

### The Affect of Immunity on This Equipment

The affect of the European Specification EN61000-6-1 (coexistence of electromagnetic waves - common immunity specification) on this equipment are as shown below.

In the electrical fast transient/burst requirements, surge, conducted disturbances by radio-frequency fields, power frequency magnetic field, radiate electromagnetic field requirements and static electricity discharging environment, this could be affected by generation of noise in some cases.

## FOSTEX DISTRIBUTORS LIST IN EUROPE

\* Including non-EU countries (as of January 2007)

### <AUSTRIA>

NAME: ATEC Audio-u. Videogeraete VertriebsgesmbH.  
 ADD: Im Winkel 5, A-2325 Velm, Austria  
 TEL: (+43) 2234-74004, FAX: (+43) 2234-74074

### <BELGIUM>

NAME: General Audio  
 ADD: Raymond Pelgrimslaan 101, B-1702 Groot-Bijgaarden, Belgium  
 TEL: (+32) 2-4630650, FAX: (+32) 2-4661500

### <DENMARK>

NAME: SC Sound ApS  
 ADD: Malervej 2, DK-2630 Taastrup, Denmark  
 TEL: (+45) 4399-8877, FAX: (+45) 4399-8077

### <FINLAND>

NAME: Noretron Oy Audio  
 ADD: P. O. Box 22, FIN-02631 Espoo, Finland  
 TEL: (+358) 9-5259330, FAX: (+358) 9-52593352

### <FRANCE>

NAME: Sennheiser France  
 ADD: 128 bis, avenue Jean-Jaures, 94851 Ivry-sur-Seine Cedex, France  
 TEL: (+33) 1 4987 0300, FAX: (+33) 1 4987 0324

### <GERMANY>

NAME: Mega Audio GmbH  
 ADD: Stromberger Str. 32, D-55411 Bingen, Germany  
 TEL: (+49) 6721-94330, FAX: (+49) 6721-32046

### <GREECE>

NAME: Bon Studio S. A.  
 ADD: 6 Zaimi Street, Exarchia, 106.83 Athens, Greece  
 TEL: (+30) 210-3809-605, 606, 607, 608  
 FAX: (+30) 210-3845-755, 210-3827-868

### <ICELAND>

NAME: I. D. elrf. electronic Ltd.  
 ADD: ARMULA 38 108 REYKJAVIK, ICELAND  
 TEL: (+354) 588 5010, FAX: (+354) 588 5011

### <ITALY>

NAME: Proel S. p. A.  
 ADD: Zona Via Alla Ruenia, 37/43 64027 - Sant'Omero (Teramo), Italy  
 TEL: (+39) 0861-81241, FAX: (+39) 0861-887862

### <THE NETHERLANDS>

NAME: IEMKE ROOS AUDIO B. V.  
 ADD: Kuiperbergweg 20, 1101 AG Amsterdam, The Netherlands  
 TEL: (+31) 20-697-2121, FAX: (+31) 20-697-4201

### <NORWAY>

NAME: Siv. Ing. Benum AS  
 ADD: P. O. Box 145, Vinderen, 0319 Oslo, Norway  
 TEL: (+47) 2213 9900, FAX: (+47) 2214 8259

### <PORTUGAL>

NAME: Caius - Tecnologias Audio e Musica, Lda.  
 ADD: Praca do Bom Sucesso, No 61 Bom Sucesso Trade Center, Escritorio 701/702, 4150 - 146 Porto, Portugal  
 TEL: (+351) 22-608-06-10, FAX: (+351) 22-608-06-29

### <SPAIN>

NAME: Letusa S. A.  
 ADD: C/Laguna 10, 28923 Alcorcon, Madrid, Spain  
 TEL: (+34) 91-4862800, FAX: (+34) 91-6414597

### <SWEDEN>

NAME: Sennheiser AB  
 ADD: John Ericssonsgatan 10, P. O. Box 22035, SE-104 22 Stockholm, Sweden  
 TEL: (+46) 8 566 16400, FAX: (+46) 8 566 16490

### <SWITZERLAND>

NAME: Audio Bauer Pro AG  
 ADD: Bernerstrasse-Nord 182, CH-8064 Zurich, Switzerland  
 TEL: (+41) 1-4323230, FAX: (+41) 1-4326558

### <UK>

NAME: SCV London  
 ADD: 40 Chigwell Lane, Oakwood Hill Industrial Estate, Loughton, Essex IG10 3NY U. K.  
 TEL: (+44) 20-8418-0778, FAX: (+44) 20-8418-0624

## FOR THE US CUSTOMERS ONLY

### FOSTEX AMERICA LIMITED WARRANTY

The following statement defines specific legal rights. You may also have additional rights depending on the state in which the Fostex product was purchased.

#### WARRANTY PROTECTION

All Fostex parts are warranted for one (1) year from the date of original purchase, except for recording media, such as hard disc drives and compact flash cards, heads, lamps and fuses, which are warranted, for one hundred-eighty (180) days. Fostex America will repair and / or replace parts during the term of this warranty. Labor costs are also covered by Fostex America for one (1) year from the date of original purchase. Except as specified below, this warranty covers all defects in material and workmanship in this product.

The following are not covered by this warranty:

1. Batteries.
2. Damage to any product that has been altered.
3. Damage to any product on which the original serial number has been defaced, modified or removed.
4. Damage to or deterioration of the external cabinet.
5. Damage occurring during shipment of the product. (**NOTE:** Shipping claims must be presented to the carrier.)
6. Damage resulting from accident, misuse, abuse or neglect.
7. Damage resulting from failure to perform routine maintenance and / or calibration procedures.
8. Damage resulting from failure to follow instruction in the owner's manual.
9. Damage resulting from repair or attempted repair or by someone other than a Fostex America Service technician or a technician at an authorized Fostex America service station.
10. Damage resulting from causes other than product defects, including lack of technical skill, competence or experience on the part of the user.
11. External appearance items such as cosmetic parts, knobs, liquid crystal displays, buttons, etc.
12. Replacements or repairs necessitated by loss or damages resulting from any cause beyond the control of Fostex America.
13. Damage resulting from misuse or abuse on rental units.

**NOTE: FOSTEX AMERICA IS NOT RESPONSIBLE FOR DATA LOST OR DAMAGED DURING OPERATION OF THIS PRODUCT.  
CALIBRATION AND MAINTENANCE PROCEDURES ARE NOT COVERED BY THIS WARRANTY.**

Fostex America reserves the right to inspect all products submitted pursuant to this warranty. If such an inspection shows reasonable cause to believe that any of the above exclusions to the above warranty are applicable, then Fostex America or the authorized service station will charge prevailing service rates and parts, costs for any repairs.

## **FOSTEX AMERICA LIMITED WARRANTY**

To claim all warranty service, first access [www.fostex.com](http://www.fostex.com) to receive service authorization (RMA number). Then present the authorization together with the bill of sale, which shows the date of original purchase to Fostex America. This warranty is not transferable.

### **SHIPPING**

If this product needs service, you must take it, or package it carefully, using ample packaging materials to prevent damage during shipment and mail it to the distributor from whom you have purchased this product, postage pre-paid and insured.

**NOTE:** Fostex America will not assume responsibility for damages or losses occurred in transit, but will reasonably assist the sender in processing any claims whenever possible (such as submitting statements to the carriers when applicable).

Any collect or C.O.D. shipments will be refused. In order to obtain warranty repairs, you must include the following:

1. Date proof of original purchase (copy of bill of sale or charge slip).
2. A note describing the problem with sufficient particularity to allow Fostex America to inspect or adjust the problem.
3. All accessory items appurtenant to that problem.

### **LIMITATIONS OF IMPLIED WARRANTIES AND EXCLUSIONS OF CERTAIN DAMAGES**

Unless considered unenforceable or unlawful under applicable law:

- A. All implied warranties - including warranties of merchantability and fitness for a particular purpose - are limited in duration to term of this warranty and to the express coverage of this warranty;
- B. Fostex America's liability for any defect product is expressly limited to repair or replacement of the product, at the sole discretion and / or option of Fostex America. Fostex America shall not under any circumstances be liable for:
  1. Damaged based on inconvenience, loss of use of the product, loss of time, interrupted operation or commercial loss, OR;
  2. Any damages, whether incidental, consequential or otherwise, except damages which may not be excluded by under applicable law.
- C. Fostex America makes no other warranties, express or implied, above and / or beyond the representations made herein.

### **WARRANTY APPLIES ONLY TO THOSE PRODUCTS SOLD AND DISTRIBUTED BY FOSTEX AMERICA**

Service Department

**FOSTEX AMERICA**

13701 Cimarron Avenue Gardena, CA 90249

TEL: (310)-329-2960 FAX: (310)-329-1230

[www.fostex.com](http://www.fostex.com)



**Fostex**<sup>®</sup>

**FOSTEX CO.**

3-2-35, Musashino, Akishima-shi, Tokyo, Japan 196-0021

**FOSTEX AMERICA**

13701, Cimarron Avenue, Gardena, CA 90249, U. S. A.