

5060: 24x2 Desktop Mixer User Guide

Thank you for your purchase of a 5060 Desktop Mixer.

Everyone at Rupert Neve Designs hope you enjoy using this tool as much as we have enjoyed designing and building it. Please take note of the following list of safety concerns and power requirements before using the 5060 module.

Safety

It's usual to provide a list of "do's and dont's" under this heading but mostly these amount to common sense issues. However, here are important safety requirements that must be adhered to:

- 1) Read these instructions.
- 2) Keep these instructions.
- 3) Heed all warnings.
- 4) Follow all instructions.
- 5) Do not use this apparatus near water.
- 6) Clean only with a dry cloth.
- 7) Do not block any ventilation openings. Install in accordance with the manufacturer's instructions.
- 8) Do not install near any heat source such as radiators, heat registers, stoves, or other apparatus (including amplifiers) that produce heat.
- 9) Do not defeat the safety purpose of the polarized or grounding-type plug. A polarized plug has two blades with one wider than the other. A grounding type plug has two blades and a third grounding prong. The wide blade or the third prong are provided for your safety. If the provided plug does not fit into your outlet, consult an electrician.
- 10) Protect the power cord from being walked on or pinched, particularly at plugs convenience receptacles and at the point where the cord exits from the apparatus.
- 11) Only use attachments/accessories specified by the manufacturer.
- 12) Unplug this apparatus during lightning storms or when unused for long periods of time.
- 13) Refer all servicing to qualified service personnel. Servicing is required when the apparatus has been damaged in any way, such as when power-supply cord or plug is damaged, liquid has been spilled or objects have fallen into the apparatus, the apparatus has been exposed to rain or moisture, does not operate normally, or has been dropped.
- 14) Do not expose this apparatus to rain or moisture.
- 15) The apparatus shall be connected to a mains socket outlet with a protective earthing connection.

Heat generated by the module is radiated through the case work, and by a silent fan at the back of the module. Ventilation holes should not be covered or blocked for any reason. To avoid overheating, 5060 units should not be stacked immediately above or adjacent to other equipment that get hot. Also bear in mind that other equipment may radiate strong hum fields which could spoil the performance of your 5060.

Protect the power cord from being walked on or pinched, particularly at plugs convenience receptacles and the point where they exit from the apparatus. Do not defeat the safety purpose of the polarized or grounding-type plug. A polarized plug has two blades with one wider than the other. A grounding type plug has two blades and a third grounding prong. The wide blade or the third prong are provided for your safety. Unplug the module during lightning storms or when unused for long periods of time.

Don't operate your 5060 module in or around water! Electronic equipment and liquids are not good friends. If any liquid is spilled, such as soda, coffee, alcoholic or other drink, the sugars and acids will have a very detrimental effect. Sugar crystals act like little rectifiers and can produce noise (crackles, etc.). SWITCH OFF IMMEDIATELY because once current starts to flow the mixture hardens, can get very hot (burnt toffee!) and cause permanent and costly damage. If it gets wet and you suspect that good clean water may have gotten in, immediately unplug the unit, and remove it from the source of water. Please contact service as soon as possible at service@rupertneve.com for resolution. Clean only with a dry cloth.

5060 Block Diagram

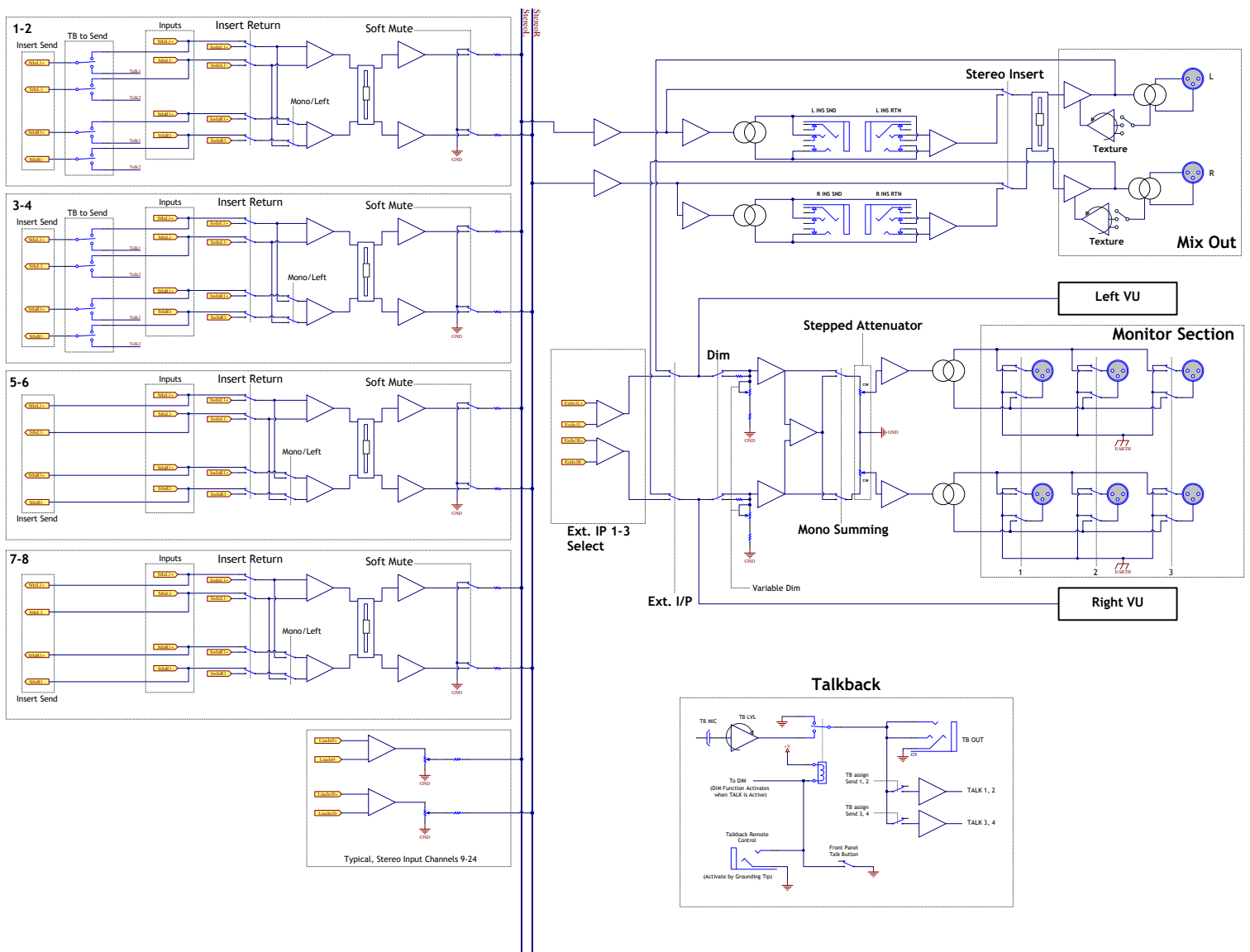

Power Requirements

Each 5060 unit has high quality, low noise switching power supplies that are further filtered and regulated for an exceptionally quiet and reliable power source for the audio circuits. The power supply is considered “universal” in the sense that it will accept 100V through 240V AC and with 50 or 60Hz. Be absolutely sure to disconnect mains power (remove the power cable from the IEC power connector at the back panel) before servicing. The fuse is on the power supply and is not user accessible. The fuse should only be replaced by a qualified service technician.

The fuse is a protection device intended to prevent additional damage or hazard if the 5060 unit develops a problem. The symptom of a blown fuse is simply that the unit does not power up. If this happens, you should contact your dealer or email service@rupertneve.com.

The Rupert Neve Designs 5060 Overview

From the father of the recording console comes the 5060 Centerpiece: the Class-A analog heart of your 21st-century studio. Sized for your desktop, the 5060 delivers the tonality and center section features of Rupert’s flagship 5088 console at your fingertips, cementing outboard together with serious custom transformers, flexible monitoring, DAW transport controls, and the raw power of a Rupert Neve-designed 24×2 mix-buss.

With a modular, hybrid analogue/digital mix system built around the 5060, you can outfit your studio with exactly what you need – and nothing that you don’t. Utilizing modern DAW control technologies, the 5060 seamlessly integrates stem outputs from the DAW with the rest of your control room, sums the final mix, and provides 2-track outputs, source selection, and speaker feed outputs from the monitor section.

In the 5060, amplification is handled with fully class-A operational amplifier topologies featuring Rupert’s custom transformer designs. While these circuits share a lineage with the circuits used in Rupert’s consoles from the 70’s, and in many ways sound similar, there are refinements in noise, slew rate, dynamic range and particularly avoidance of unpleasant high frequency distortion artifacts.

With proper implementation, the 5060 can redefine the sonic possibilities and streamline workflow in the hybrid DAW and analogue based studio.

Quick Start: Configuration Suggestions for the 5060

The 5060 is designed to function both as a mixer, and as a way to tie together your studios analogue and digital components. By configuring mix systems based around the 5060 and 5059 Satellite Summing Mixers, any number of studio workflows can be accommodated. While there is no “right” way to connect the 5060, here are a few suggestions to get started:

The 5060 is designed to integrate your analogue components like outboard processing, speakers, and headphone amplifiers with the outputs from your DAW. Although one could conceivably use parts of the 5060 in the pre DAW path, all of our suggestions use the 5060 entirely in the post DAW or “mix” path. In the “Lone 5060” configuration, up to 12 separate stereo pairs (stems) can be outputted from the DAW through the DAC and into the 5060 for analogue mixing. Stereo inputs 1-8 may also be used as mono center channels to allow for latency free integration of analogue processing on key tracks like lead vocals during mixing. Stereo sends may also be sent out of the DAW and into reverbs, delays, or any processors for use as effects inputs to the mix buss with channels 9-24.

"The Lone 5060"

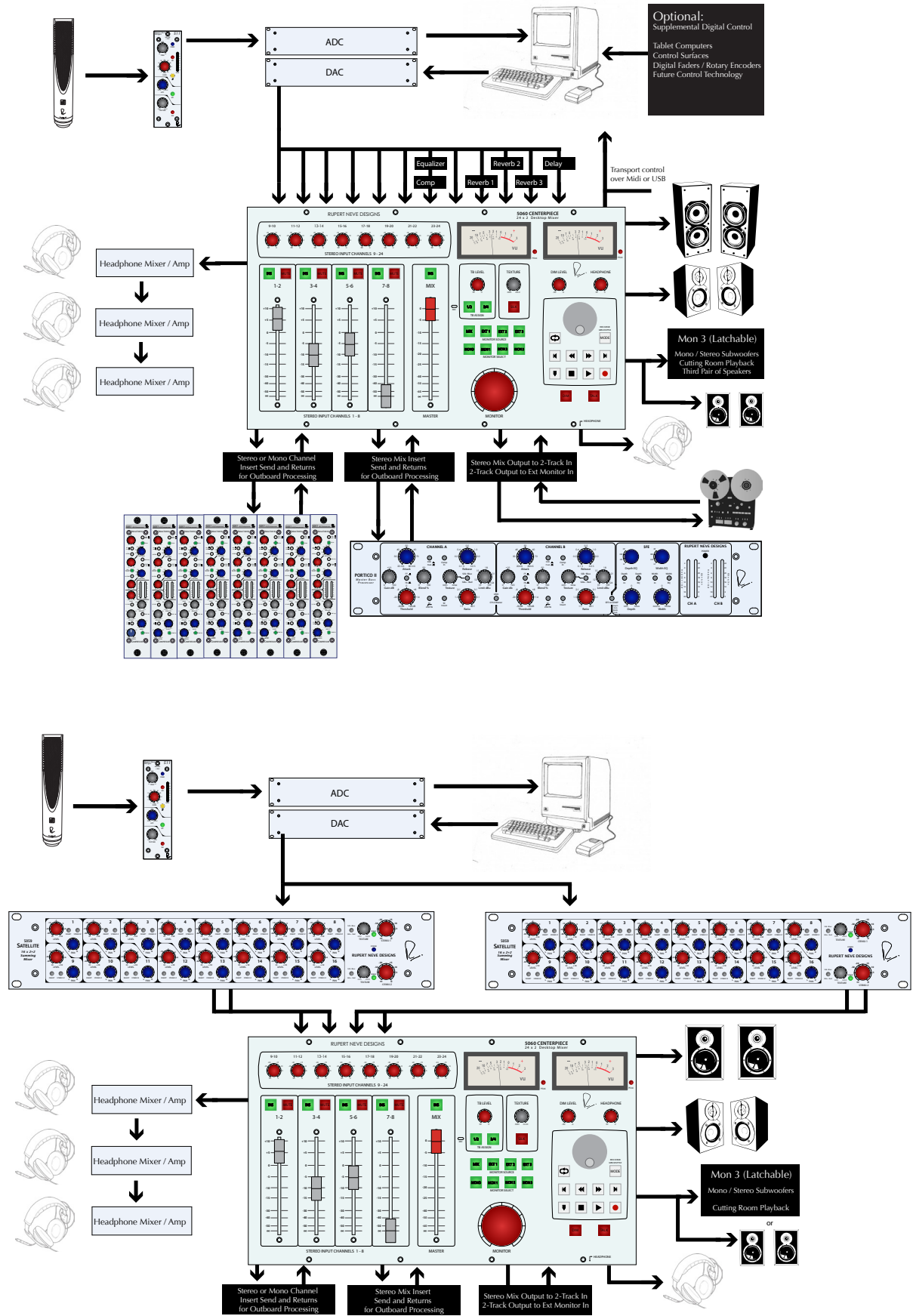

"5059's Creating Auxes and Mixing into a 5060"

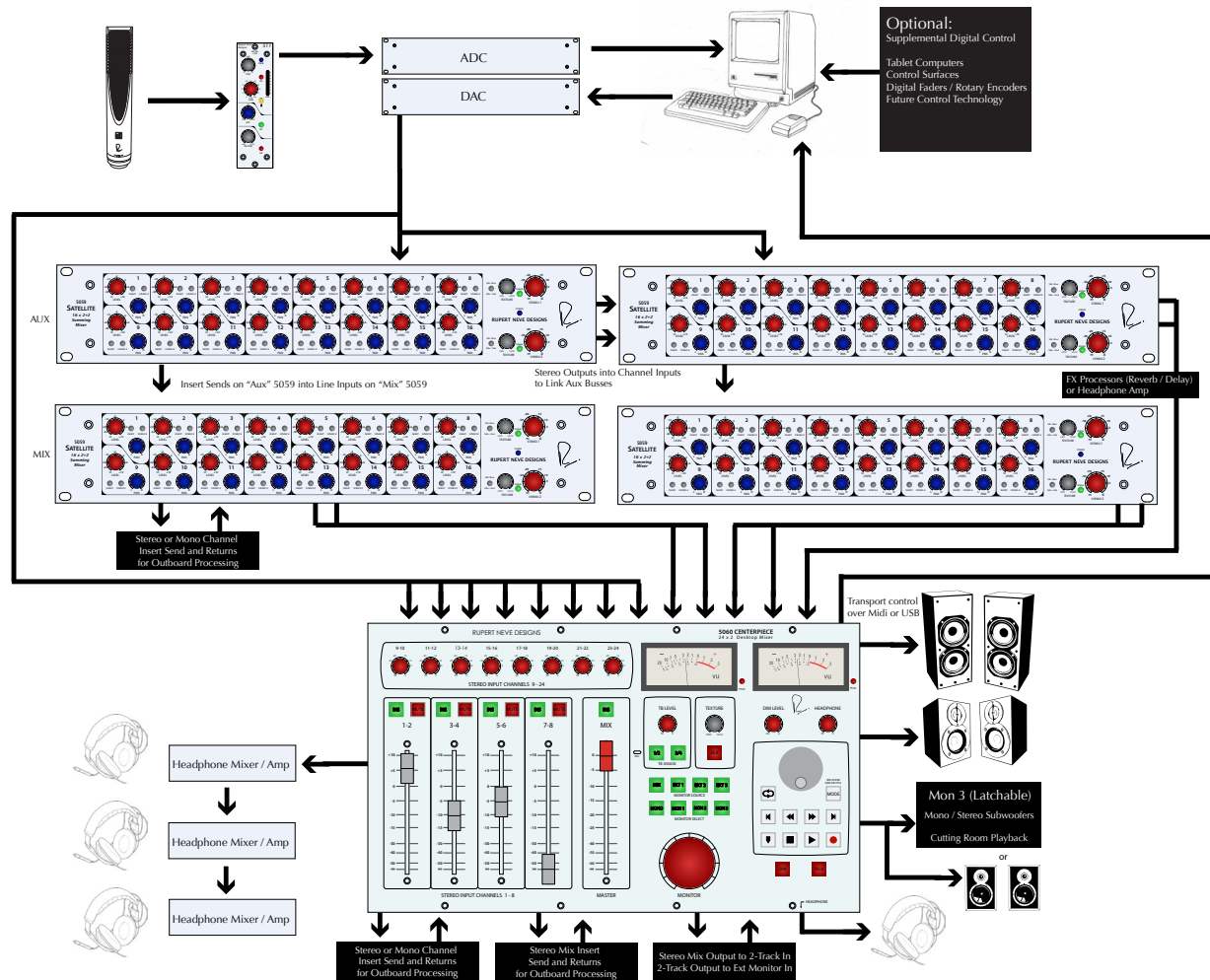

For setting up headphone sends with multi-channel cue mix systems, you can use the insert sends of stereo input channels 1-8 to feed 8 channels to the cue mix system, with talkback assigned directly to both 1-2 and / or 3-4.

Because the sends are always pre-fader, you can also route stereo cue mixes from stereo outputs on the DAW through channels 1-2 and / or 3-4 with the mutes engaged to apply talkback to the stereo cue mixes. The external talkback out can also be sent directly to a separate headphone mixer (or DAW if you are creating cue mixes in the digital domain).

For analogue processing, the channel inserts and mix inserts may be used to easily connect to hardware signal processors such as EQ's and compressors. Signal processing may also be added through a patchbay between the DAW and any of the stereo inputs 1-24. This can be useful if you are looking to create auxes in the DAW and send them out through a hardware reverb or delay and then return them into the 5060. One other way you can integrate hardware is to take the insert send signals on channels 1-8, run them out through processors like EQ and Compression, and then return them to a stereo pair on channels 9-24 for parallel stem processing.

The stereo output is routed to a 2-track recorder (this can be your DAW if you don't have a specific device), and then the outputs of the 2-track recorder are returned to the Ext Monitor Source Select so you can monitor the final master buss signal. You may also wish to hook up things like ipod docks or

Talkback Level / Assign / Mic

Controls the level of the talkback mic to the talkback output, and assigns the output to monitor out 1-2 & 3-4

Aux Stereo Inputs

8 active stereo inputs with rotary faders for stem and aux inputs

Stereo Channel Inserts

Passive stereo insert send / return. The send signal is always active

Stereo Channel Mutes

Mutes the signal on the 4 main stereo input channels

Stereo Channel Faders

100mm Fader determines the level of the 4 main stereo input channels. Faders can be either stereo or center-panned mono from the left input

Master Stereo Insert

Transformer coupled insert where the send signal is always active. Engaging the insert button selects the insert return signal

Master Stereo Fader

Determines the level of the master stereo buss signal

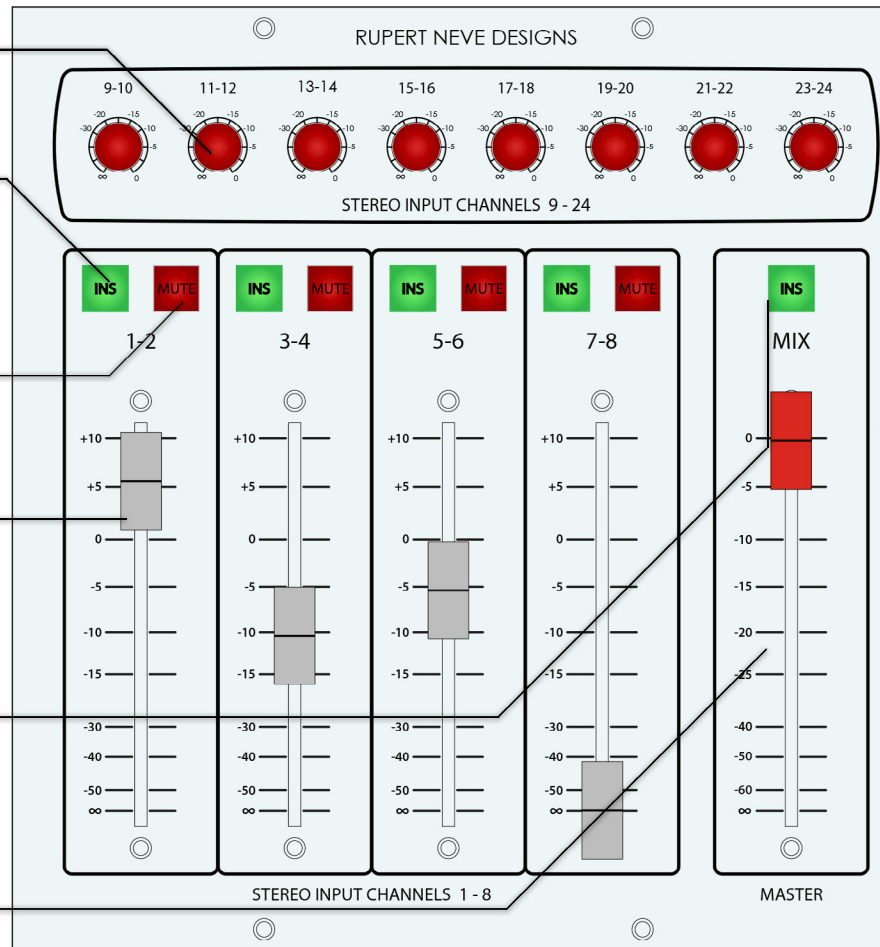

Monitor Speaker Select

Selects which speaker output is active. By holding the Mon 3 button, the Mon 3 outputs will remain on with either Mon 1 or 2 for use with subwoofers or speakers in the cutting room

Silk

Toggles between Silk Red, Silk Blue, or no Silk

Texture

Determines the amount of Silk effect, when Silk is engaged

L/R Meters & Peak Indicators

VU Meters Display the RMS signal level of the selected monitor source, and the peak indicator illuminates red when the peak threshold has been exceeded.

Dim Level

Sets the amount of monitor signal attenuation that occurs when the Dim button is depressed

Headphone Level

Controls the level of the headphone output

Shuttle / Jog Wheel

Used to control either scrub or shuttle functions in the DAW

Transport Controls

Control the standard transport functions of a DAW through Midi or USB interconnection

Marker Drop

Creates a marker in the DAW

Talkback Engage

Momentary switch, dims the speakers and enables the talkback send

Dim Engage

Latching switch, dims the monitor signal according to the Dim Level

Monitor Level

21 Position rotary stepped attenuator determines the level of the speaker output

Monitor Source Select

Selects the Monitor Source for the speakers and headphone outputs

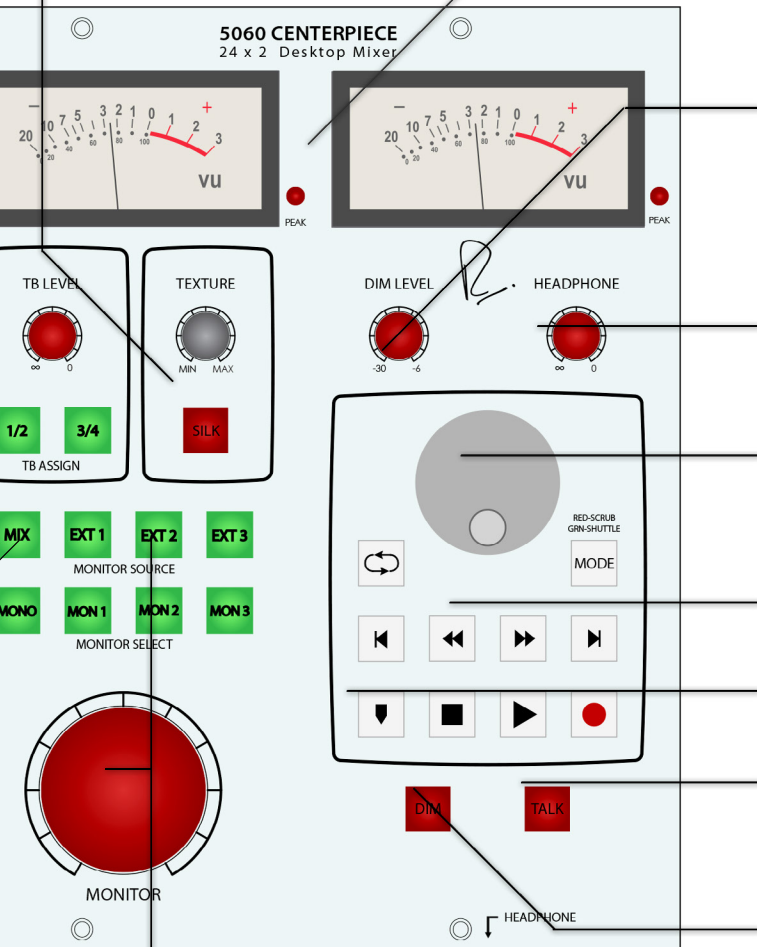

turntables to the other Ext Inputs to be able to listen to reference material.

There are three pairs of speaker outputs which are selected by the monitor select, and controlled by the monitor level rotary stepped attenuator. The switches are designed such that only one pair of speakers may be on at a time. The Mon 3 switch however can be made to “latch” by holding the button for 2 seconds such that you may use Mon 3 at the same time as either Mon 1 or 2. This is useful for setting up a mono or stereo subwoofer system, or as a way to pipe monitor signal into the cutting room or a separate listening area.

In the “5059’s Mixing into a 5060” configuration, 32 separate mono channels can be fed into two 5059’s for level, pan, and insert control (16 ch. for one 5059). You can create four stem mixes with the two 5059s, which can each have their own silk / texture settings and level of mix buss drive. These stems can then be processed further using the inserts on channels 1-8, which can be returned to the return, or in parallel to Ch. 9-24. They can also be run through processing via a patchbay between the 5059 line outs and the 5060 inputs. You may still send an additional eight stems from the DAW through the DAC and into the 5060 for the final analogue mix.

In the “5059’s Creating Auxes and Mixing into a 5069” configuration, 5059’s are configured to add aux functionality to a 5059 / 5060 mix system by daisy chaining the insert sends to the line inputs on another 5059 or 5060 and using the stereo 1 & 2 outs as the aux masters. For configurations with more than 16 channels, you will need to use 2-4 channels for each additional 5059 (every 16ch) to link the aux busses between units. If you would like the same processing on both the aux path and the mix path it needs to be inserted before the line inputs on the “aux” 5059. For the 5059s creating the stereo stems into the 5060, the configuration is identical to the “5059s Mixing into a 5060” example.

HOW TO CALIBRATE FOR A DIGITAL MIX IN ANALOGUE

For engineers looking to completely recreate their digital mix in the analogue domain, and not use the level controls on the 5060, it is advisable to take the time to calibrate the 5060 on each channel since there can be variances in the tracking of any continuous potentiometer or fader.

To do this, create a tone generator in the DAW and assign it channel 1-2 with the output level at 0dB. Make sure SILK is off, and the stereo output gain on the 5060 is set to 0dB. Patch the stereo output to the 2-track destination (the device that is going to capture the mixed stereo signal).

Adjust the level until the meters on the input of the 2-track destination reads a predetermined level (for most purposes -6dB should work). Repeat by changing the tone generator output to each stereo channel and adjusting to the same chosen level on the 2-Track device.

Patchbay Configurations

The 5060 can be used without a patchbay; however, if you have a number of outboard modules, we recommend using a patchbay to allow easy integration with outboard equipment.

How you configure the patchbay depends entirely on your existing studio, although there are a few general conventions that tend to make the workflow smoother. The source for the 5060 (generally a digital to analogue converter from a DAW) should have its outputs normalised to the inputs of the 5060. This makes it so the outputs from the source automatically flow into the 5060, but they can still be patched to another destination on the fly if need be.

5060 Back Panel

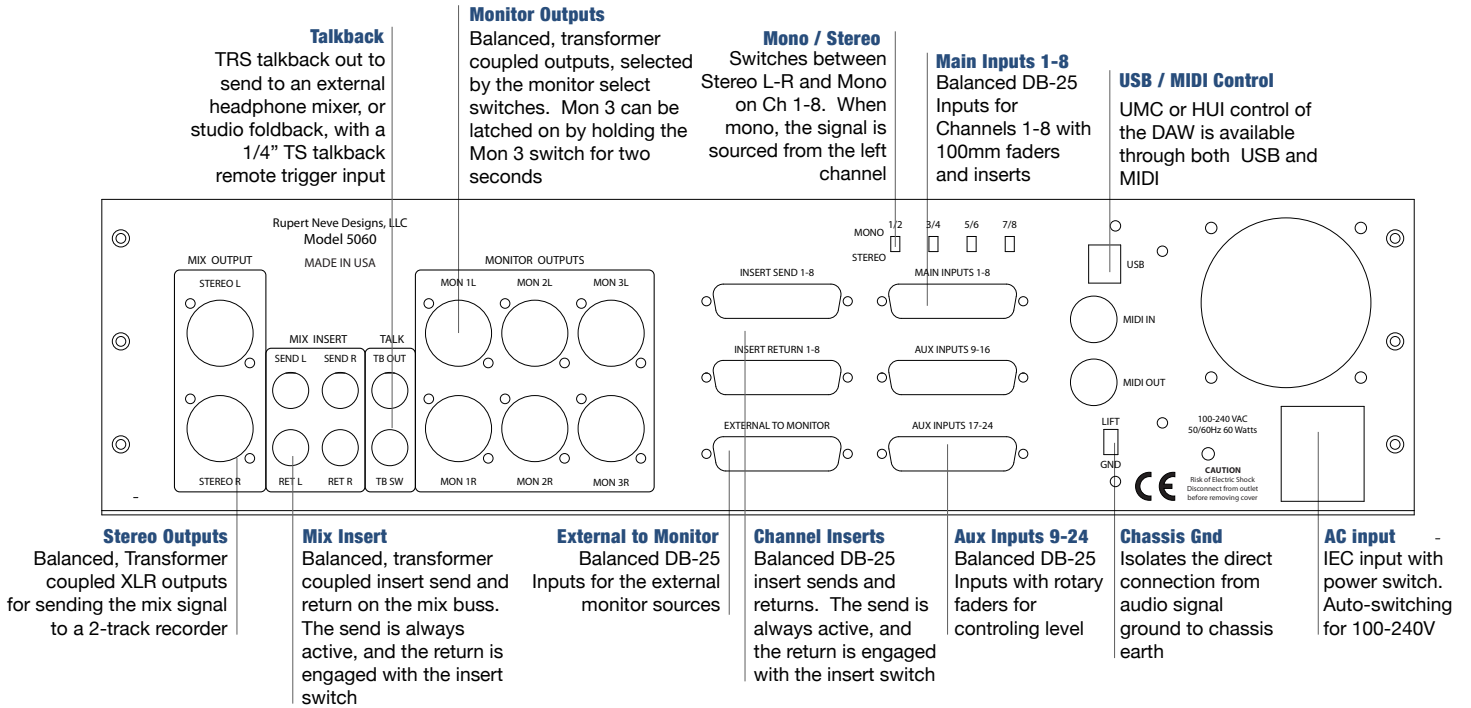

While you can patch the source into a processing module before the input of the 5060 on channels 1-24, we recommend also normalling the insert send and return together on another row of the patchbay for channels 1-8, as to avoid cutting off the signal when the insert is engaged with nothing patched in. For using the faders as mono center channels, the signal will be sourced from the left input (i.e. 1,3,5,7).

DB 25 Connector Pinout

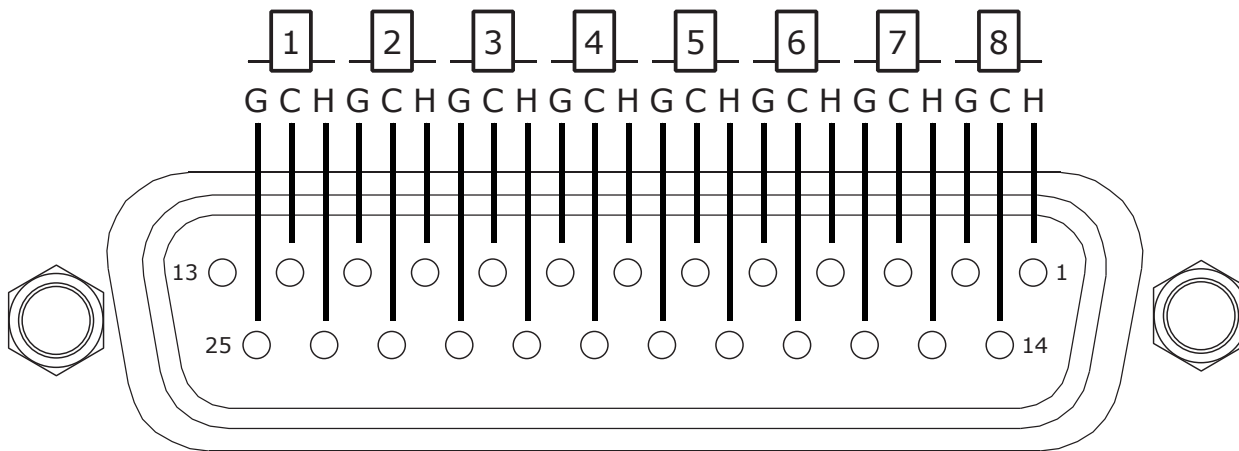

USB / MIDI Setup Instructions

Either USB or MIDI can be used to provide DAW transport control from the 5060. The USB functionality of the 5060 is plug and play in both PCs (win 7 and newer) and Mac (10.3 and newer). For older operating systems, the USB may work, however we recommend using a MIDI interface. 5060: Rupert

Neve Designs will show up as a USB MIDI Device or USB Audio Device in the system device manager and will be available in the device / peripherals / control surface setup in your DAW. For MIDI setup, simply connect the MIDI in / out on the 5060 to a MIDI in port on your MIDI interface, and the MIDI in port on the 5060 to the MIDI out port on your MIDI interface.

Here are a few quick guidelines for the digital setup of the 5060, specifics may differ from program to program, so please follow your DAW's instructions for adding a MIDI controller:

1. Connect either the MIDI or the USB input. **DO NOT CONNECT BOTH AT THE SAME TIME!!!**
2. If you have open midi connections available on an Audio or MIDI interface, it is preferable to use your existing connections to minimize the number of devices connected to the computer.
3. Depending on the DAW Program, various functions like jog / shuttle may not work the same as in other DAWs. Standard commands however, such as stop, start, fast-forward, rewind, should work the same in nearly every program.

For use with Avid Pro Tools, the 5060 should be setup as a HUI Device under Peripherals > Midi Controllers in Pro Tools. Be sure to launch Pro Tools as administrator by right clicking on the application if you haven't done so before.

For use with other DAW's including Logic, Steinberg Nuendo, Cubase, Digital Performer and others, the 5060 should be setup as a "MCU device" in your DAW's setup. If MCU device is not available, select Mackie HUI device.

Line Inputs and Outputs

The input and output stages of the 5060 are similar to that of the 5088 console, using class-A circuitry, driving a carefully configured output transformer that can deliver a full +26dBu from the balanced and ground-free secondary winding.

This maximum level provides a large margin over and above the likely maximum requirement of any destination equipment to which the module may be connected. This is especially true when feeding digital equipment!

Freedom from the interference fields that are inevitably present in any control room is virtually guaranteed by the balanced, ground-free design used in the 5060. The classic Rupert Neve designed modules always used transformers, as do a number of other high quality vintage modules still in current use.

High quality transformer connectivity has been used for many years, enabling modular amplifier units to deliver the sonic performance for which they are famous. The outputs are very appropriate for driving long lines that may be needed when the 5060 is used remotely.

Bear in mind that human ears are very sensitive and can perceive incredibly minute interference signals that are not part of the "desired" signal. If unbalanced connections are used, great care must be exercised to avoid ground loops and common signal paths. Reduced immunity from various forms of interference can be tolerated (sometimes), but this usually results in a loss of resolution.

In certain applications, the output of the 5060's transformer-coupled XLR may be used with one side grounded. For example to use with "Hi-Fi", "consumer" or other unbalanced audio gear, without

degrading the performance of such devices. Care must be exercised when using ancillary equipment to avoid overloading these devices.

Chassis

The chassis is designed to work on a flat surface like a desktop or table. If you are looking to rack mount it, in a standard 19" rack width, please email service@rupertneve.com for more information. The construction incorporates a heavy and robust steel shell that provides total magnetic screening and exceptional mechanical stability. The front panel is machined from a solid aluminum plate with a steel sub panel behind it. The side cheeks are milled from solid mahogany.

5060 Controls

CHANNEL LEVEL

To control the mix of input signals, the 5060 has 4 Stereo 100mm faders with a range of -infinity to +10dB and 8 stereo rotary faders with a range of -infinity to +0dB. We recommend users experiment with varying the amount of level on the channels vs. the level of the master buss to find the "sweet spot" of the 5060. By pushing the level on the channel faders on the 5060 and backing off the level of the master fader, the mix insert can be engaged and the insert send transformers can be driven to create a dynamic saturation effect on the mix buss.

MASTER OUTPUT LEVEL

The Master Fader uses a 100mm fader with a range from -infinity to 0dB. If you are "pushing" the mix buss to get more tone out of the 5060, you may need to lower the master output fader to avoid clipping your 2-track destination.

CHANNEL INSERT SEND / RETURN

The channel insert sends are mults of the input signal that is always active. When the insert button is engaged, the insert return signal replaces the standard input signal.

In use, the inserts are helpful in auditioning various pieces of outboard equipment, but they can also be used several other ways. The insert return can be used as a selectable second hardwire input to the 5060, for instance, if you have both a digital recorder and a tape machine, you can patch one to the line in and one to the insert return. The insert send can also be used as a way to feed headphone queue systems with talkback signals routed into channels 1-2 and / or 3-4.

CHANNEL MONO / STEREO SWITCHING

Input channels 1-8 are stereo by default, however they may be switched to mono center to enable processing on mono tracks like lead vocals, snare drum, etc. The switches are at the top of the back panel and select the left input (1,3,5,7) as the mono source. The right channel will not be passed through.

SILK / TEXTURE

Pushing the SILK button engages the silk red circuit, and pushing it a second time introduces silk blue circuitry. Silk reduces the negative feedback on the output transformer, adding vintage flavor as the texture is increased. Silk red mode accentuates the saturation in the high-mids and highs, while silk blue mode features more saturation in the lows and low mids.

In the 5060, both silk modes are modified and fine tuned by the texture control. By manipulating the

texture control, the amount of silk can be changed from essentially absent, to roughly three times the amount of coloration found in silk from the original Portico Series.

With silk/texture engaged, the distortion characteristic and harmonic content of the unit are very reminiscent of many of Rupert's class-A vintage designs. These controls add an unparalleled range of tonal options to the 5060 and should be explored creatively with a variety of different sources for best effect.

The silk / texture control can be used to good effect on almost any source material by varying the texture control accordingly. Although we highly encourage you to experiment to find your favorite results, here are a few rough ideas and suggestions for both Silk Red and Silk Blue modes:

Silk Red: Adding sparkle to a mix . Adding brilliance and presence to vocals. Bringing out the snap and sheen on a drum buss. Accentuating the growl and brightness of electric guitars.

Silk Blue: Adding weight and density to a mix, thickening and adding a sense of closer proximity to vocals. Adding size and boominess to drum or bass buss. Warming up guitars or other instruments.

MONITOR SOURCE SELECT

The monitor source select determines the monitor source being sent to the speaker outputs and the headphone output. The 5060 can select between three stereo Ext Monitor sources and the stereo mix buss. The Ext Sources are often used to reference the return from the 2-track recorder or listen to music from a turntable or iPod dock.

MONITOR SELECT

The monitor select determines which speaker output is active. By holding the Mon 3 button, the Mon 3 outs will "latch" on, allowing both Mon 1 & 2 for use while Mon 3 remains active. The latching feature is often used for adding subwoofers or feeding speakers in the cutting room.

HEADPHONE AMPLIFIER

The headphone amplifier provides reference grade performance amplification for headphone monitoring. The headphone signal follows the selection of the Monitor Source selection.

MONITOR LEVEL

Monitor Level is controlled by a precision 21 step attenuator which provides highly accurate left/right stereo tracking, perfect repeatability.

TRANSPORT CONTROLS

The 5060 can control standard transport functions in DAWs including play, stop, record, fast-forward, rewind, loop, shuttle / jog and marker drop through either MIDI or USB interconnection. Pushing the mode button toggles between shuttle and jog modes for the rotary controller, the wheel changes from shuttle to jog. Due to differences in some DAW's, every features like Jog / Shuttle, Marker Drop and Loop may not perform the same with every software program.

TALKBACK

The included talkback mic is activated by depressing the Talkback switch. The Talkback has level control, a direct out, and assignment to insert sends 1-2 & / or 3-4. When the talkback switch is depressed, the speaker output levels are lowered according to the setting of the Dim control. The Talkback amplifier

utilizes a built in compressor to control the sensitivity of the internal TB mic under varying conditions. A talkback remote may also be plugged into the ¼" TS talkback remote input on the back of the 5060.

METERS

VU Meters Display the RMS signal level of the selected monitor source, and the peak indicator illuminates red when the peak threshold has been exceeded, which is roughly 3dB before the clipping point.

DIM

Engaged when either the Dim or Talkback switch is depressed, Dim reduces the volume of the monitor source between -6dB and -30dB adjusted with the Dim Level control.

POWER

If the rear panel switch is not pressed then the 5060 is maximally "green" and exhibits its absolute lowest noise floor. However, for any of the previously described features to have any significance, the POWER switch should be pressed. If nothing happens when the switch is pressed and not one LED even winks at you, then you may also want to plug in the Power cord too.

A Note on Distortion

The human hearing system is a remarkably complex mechanism and we seem to be learning more details about its workings all the time. For example, Oohashi demonstrated that arbitrarily filtering out ultrasonic information that is generally considered above our hearing range had a measurable effect on listener's electroencephalo-grams. Additionally, Kunchur describes several demonstrations that have shown that our hearing is capable of perceiving approximately twice the temporal resolution that a limit of 20 kHz might imply. His peer reviewed papers demonstrated that we can hear temporal resolution of approximately with 5 microseconds (20 kHz implies a 9 microsecond temporal resolution, while a CD at 44.1k sample rate has a best-case temporal resolution of 23 microseconds).

It is also well understood that we can perceive steady tones even when buried under 20 to 30 dB of noise. And we know that most gain stages exhibit rising distortion at higher frequencies, including more IM (intermodulation) distortion. One common IM test is to mix 19 kHz and 20 kHz sine waves, send them through a device and then measure how much 1 kHz is generated (20-19=1). All this hints at the importance of maintaining a sufficient bandwidth with minimal phase shift, while at the same time minimizing high frequency artifacts and distortions. All of the above and our experience listening and designing suggest that there are many subtle aspects to hearing that are beyond the realm of simple traditional measurement characterizations.

The way in which an analog amplifier handles very small signals is as important as the way it behaves at high levels. For low distortion, an analog amplifier must have a linear transfer characteristic, in other words, the output signal must be an exact replica of the input signal, differing only in magnitude. The magnitude can be controlled by a gain control or fader (consisting of a high quality variable resistor that, by definition, has a linear transfer characteristic.) A dynamics controller - i.e. a compressor, limiter or expander - is a gain control that can adjust gain of the amplifier very rapidly in response to the fluctuating audio signal, ideally without introducing significant distortion, i.e. it must have a linear transfer characteristic. But, by definition, rapidly changing gain means that a signal "starting out" to be linear and, therefore without distortion, gets changed on the way to produce a different amplitude.

Inevitably our data bank of "natural" sound is built up on the basis of our personal experience and

this must surely emphasize the importance of listening to “natural” sound, and high quality musical instruments within acoustic environments that is subjectively pleasing so as to develop keen awareness that will contribute to a reliable data bank. Humans who have not experienced enough “natural” sound may well have a flawed data bank! Quality recording equipment should be capable of retaining “natural” sound and this is indeed the traditional measuring stick. And “creative” musical equipment should provide the tools to manipulate the sound to enhance the emotional appeal of the music without destroying it. Memory and knowledge of real acoustic and musical events may be the biggest tool and advantage any recording engineer may possess.

One needs to be very careful when one hears traces of distortion prior to recording because some flavors of distortion that might seem acceptable (or even stylish) initially, may later prove to cause irreparable damage to parts of the sound (for example, “warm lows” but “harsh sibilance”) or in louder or quieter sections of the recording. Experience shows that mic preamps and basic console routing paths should offer supreme fidelity otherwise the engineer has little control or choice of recorded “color” and little recourse to undo after the fact. Devices or circuits that can easily be bypassed are usually better choices when “color” is a consideration and this particularly is an area where one might consider comparing several such devices. Beware that usually deviations from linearity carry at least as much long-term penalty as initial appeal, and that one should always be listening critically when recording and generally “playing it safe” when introducing effects that cannot be removed.

1. Tsutomu Oohashi, Emi Nishina, Norie Kawai, Yoshitaka Fuwamoto, and Hishi Imai. National Institute of Multimedia Education, Tokyo. “High Frequency Sound Above the Audible Range, Affects Brain Electric Activity and Sound Perception” Paper read at 91st. Convention of the A.E.S. October 1991. Section 7. (1), Conclusion.
2. Miland Kunchur, Depart of Physics and Astronomy, University of South Carolina. “Temporal resolution of hearing probed by bandwidth restriction”, M. N. Kunchur, Acta Acustica united with Acustica 94, 594–603 (2008) (<http://www.physics.sc.edu/kunchur/Acoustics-papers.htm>)
3. Miland Kunchur, Depart of Physics and Astronomy, University of South Carolina. Probing the temporal resolution and bandwidth of human hearing, M. N. Kunchur, Proc. of Meetings on Acoustics (POMA) 2, 050006 (2008)

Specifications

Stereo Outputs (unless otherwise specified, frequency is 1 kHz)

Max input level

Channels 1-8 , Fader at 0dB	greater than +26 dBu
Channels 9-24, Max input, level trim at 0dB	greater than +22 dBu

Max Output level

Any combination of inputs	greater than +27 dBu
---------------------------	----------------------

THD+N

Channels 1-8, fader at unity, BW <10 Hz – 80k Hz,	
+20 dBu, 20 Hz	0.03%
+20 dBu, 2 kHz	0.003%
+20 dBu, 20 kHz	0.02%

Channels 9-24, trim at unity, BW <10 Hz – 80k Hz

+20 dBu, 20 Hz

0.03%

+20 dBu, 2 kHz

0.004%

+20 dBu, 20 kHz

0.02%

Noise

BW 22 Hz – 22 kHz

1-24

Better than -90 dBV

9-24

Better than -100 dBV

X-talk

Channel to channel

Better than 60dB

CMRR

1K input to channel 1, 0 dBu fader at unity

-70 dBu

Frequency Response

10 Hz to 120 kHz

+/- 0.25 dB

185 kHz

-3 dB

IMD

+4 dBu, CCIF/DFD

Better than 0.0008%

Silk Blue/Silk Red (Texture control at maximum)

Distortion

+20 dBu in, 20 Hz

Better than 5%

+20 dBu in, 200 Hz

Better than 0.2%

Monitor Outputs

Max Output Level

1 kHz

+25 dBu

THD+N

+20 dBu, 20 Hz

Better than 0.03%

+20 dBu, 2 kHz

Better than 0.02%

+20 dBu, 20 kHz

Better than 0.02%

Noise

Ch. 1-24

Better than -90 dBV

Ch. 9-24

Better than -100 dBV

Headphone Out

Max output level

Better than +20 dBu, unloaded

THD+N

16 dBu output, 2 kHz into 68 ohms

Better than 0.02%,

Noise

(22 Hz – 22 kHz)

Better than -85 dBV

Minimum Load

16 ohms recommended

Peak LED's

Engage Threshold

+22 dBu

Power Consumption:

AC Mains, 100VAC to 240VAC, 50/60Hz

60 Watts

Fuses – not user accessible, internal on power supplies

Weight:

22lbs

Frequency Response / Saturation Plots

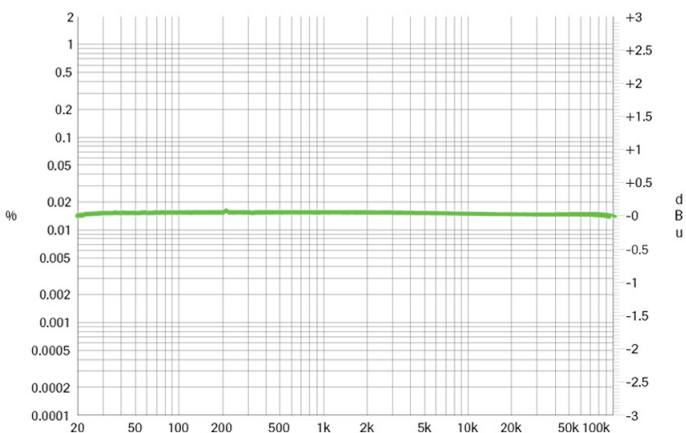

■ Frequency Response

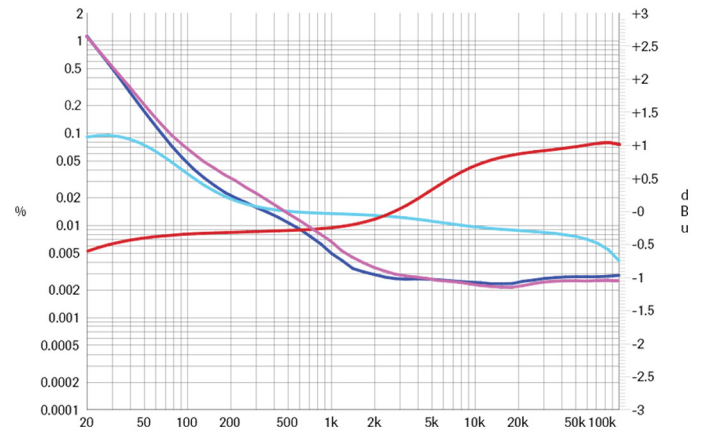

■ Freq. Response (Silk Red, Max) ■ Freq. Response (Silk Blue, Max)
■ THD + N (Silk Red, Max) ■ THD + N (Silk Blue, Max)